

Service  
Service  
**Service**

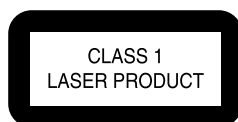

CL 16532007\_071.eps  
140201

# Service Manual



## Contents

	<b>Page</b>
1 Technical specifications and connection facilities	2
2 Warnings, laser safety instructions and notes	3
3 Directions for use	6
4 Mechanical instructions and exploded views	15
5 Diagnostic software descriptions and troubleshooting	20
6 <i>Block- and wiring diagram</i>	
Blockdiagram	39
Wiring diagram	40
7 <i>Electrical diagrams and print-layouts</i>	<i>Diagram PWB</i>
Power supply	41   42-43
A/V Board Video control      (Diagram A1)	44   46-47
A/V Board Audio              (Diagram A2)	45   46-47
Display panel                 (Diagram D)	48   49
Bare board Standby	50   50
8 Electrical alignments	51
9 Circuit descriptions and List of abbreviations	51 54
10 Spare part list	55

© Copyright 2001 Philips Consumer Electronics B.V. Eindhoven, The Netherlands.  
All rights reserved. No part of this publication may be reproduced, stored in a retrieval system or transmitted, in any form or by any means, electronic, mechanical, photocopying, or otherwise without the prior permission of Philips.



# PHILIPS

# 1. Technical specifications

## Specifications

### PLAYBACK SYSTEM

DVD-Video  
Video CD & SVCD  
CD (CD-Recordable and CD-Rewritable)  
DVD+RW

### OPTICAL READOUT SYSTEM

Lasertype	Semiconductor AlGaAs	
Numerical Aperture	0.60 (DVD)	0.45 (VCD/CD)
Wavelength	650 nm (DVD)	780 nm (VCD/CD)

### DVD DISC FORMAT

Medium	Optical Disc	
Diameter	12cm (8cm)	
Playing time (12cm)	One layer	2.15 h*
	Dual layer	4 h*
	Two side	4.30 h*
	Single layer	8 h*
Two side		
Dual layer		

### VIDEO FORMAT

DA Converter	10 bits
Signal handling	Components
Digital Compression	MPEG2 for DVD, MPEG1 for VCD

### TV STANDARD (PAL/50Hz) (NTSC/60Hz)

Number of lines	625	525
Playback	Multistandard	(PAL/NTSC)

### DVD

Horizontal Resolution	720 pixels	720 pixels
Vertical Resolution	576 lines	480 lines

### VCD

Horizontal Resolution	352 pixels	352 pixels
Vertical Resolution	288 lines	240 lines

### VIDEO PERFORMANCE

Video output	1 Vpp into 75 ohm
S-Video output	Y: 1 Vpp into 75 ohm
	C: 0.3 Vpp into 75 ohm
	Y: 1 Vpp into 75 ohm
Component video output	Pr/Cr: Pb/Cb: 0.7 Vpp into 75 ohm
Black Level Shift	On/Off
Video Shift	Left/Right

### AUDIO FORMAT

Digital	MPEG	Compressed Digital
	DTS/Dolby Digital	
	PCM	16, 20, 24 bits fs, 44.1, 48, 96 kHz

Analog Sound Stereo  
Dolby Pro Logic downmix from Dolby Digital multi-channel sound  
3D Sound (TruSurround) for virtual 5.1 channel sound on 2 speakers

### AUDIO PERFORMANCE

DA Converter	24 bits	
DVD	fs 96 kHz	4 Hz - 44 kHz
	fs 48 kHz	4 Hz - 22 kHz
Video CD	fs 44.1 kHz	4 Hz - 20 kHz
	fs 44.1 kHz	4 Hz - 20 kHz
Signal-Noise (1kHz)	100 dB	
Dynamic Range (1kHz)	97 dB	
Crosstalk (1kHz)	110 dB	
Distortion and Noise (1kHz)	88 dB	

### CONNECTIONS

Y Output	Cinch (green)
Pb/Cb Output	Cinch (blue)
Pr/Cr Output	Cinch (red)
S-Video Output	Mini DIN, 4 pins
Video Output	Cinch (yellow)
Audio L+R output	Cinch (white/red)
Digital Output	1 coaxial
	IEC958 for CDDA / LPCM
	IEC1937 for MPEG1/2, Dolby Digital and DTS

### CABINET

Dimensions (w x h x d)	435 x 92 x 320 mm
Weight	Approximately 4 Kg

### GENERAL FUNCTIONALITY

Stop / Play / Pause  
Fast Forward / Backward  
Time Search  
Step Forward / Backward  
Slow Motion  
Title / Chapter / Track Select  
Skip Next / Previous  
Repeat (Chapter / Title / All) or (Track / All)  
A-B Repeat  
Shuffle  
Scan  
New enhanced user graphical interface  
Perfect Still with digital multi-tap filter  
Zoom (x1.33, x2, x4) with picture enhancement  
Screen Saver (Dim 75% after 15 minutes)  
3D Sound (TruSurround)  
Virtual Jog Shuttle  
Audio and video bit rate indicator

### DVD FUNCTIONALITY

Multi-angle Selection  
Audio Selection (one out of maximum eight languages)  
Subtitles Selection (one out of maximum 32 languages)  
Aspect Ratio conversion (16:9, 4:3 Letterbox, 4:3 Pan Scan)  
Parental Control and Disk Lock  
Disc Menu support (Title Menu and Access Control)  
Resume (5 discs) after stop / standby  
Programming Titles/chapters with Favorite Track Selection

### VIDEO CD FUNCTIONALITY

Playback Control for VCD 2.0 discs  
Disc Lock  
Resume (5 discs) after stop / standby  
Programming Tracks with Favorite Track Selection

### AUDIO CD FUNCTIONALITY

Time Display (Total / Track / Remaining Track Time)  
Full audio functionality with remote control  
Programming with Favorite Track Selection

\* typical playing time for movie with 2 spoken languages and 3 subtitle languages

Specifications subject to change without prior notice

## 2. Warnings and Laser safety instructions

### GB WARNING

All ICs and many other semi-conductors are susceptible to electrostatic discharges (ESD). Careless handling during repair can reduce life drastically.

When repairing, make sure that you are connected with the same potential as the mass of the set via a wrist wrap with resistance.

Keep components and tools also at this potential.



### NL WAARSCHUWING

Alle IC's en vele andere halfgeleiders zijn gevoelig voor elektrostatische ontladingen (ESD).

Onzorgvuldig behandelen tijdens reparatie kan de levensduur drastisch doen verminderen.

Zorg ervoor dat u tijdens reparatie via een polsband met weerstand verbonden bent met hetzelfde potentiaal als de massa van het apparaat.

Houd componenten en hulpmiddelen ook op hetzelfde potentiaal.

### F ATTENTION

Tous les IC et beaucoup d'autres semi-conducteurs sont sensibles aux décharges statiques (ESD).

Leur longévité pourrait être considérablement écourtée par le fait qu'aucune précaution n'est prise à leur manipulation.

Lors de réparations, s'assurer de bien être relié au même potentiel que la masse de l'appareil et enfiler le bracelet serti d'une résistance de sécurité.

Veiller à ce que les composants ainsi que les outils que l'on utilise soient également à ce potentiel.

### D WARNUNG

Alle IC und viele andere Halbleiter sind empfindlich gegen elektrostatische Entladungen (ESD).

Unvorsichtige Behandlung bei der Reparatur kann die Lebensdauer drastisch vermindern. Sorgen Sie dafür, dass Sie im Reparaturfall über ein Pulsarmband mit Widerstand mit dem Massepotential des Gerätes verbunden sind.

Halten Sie Bauteile und Hilfsmittel ebenfalls auf diesem Potential.

### I AVVERTIMENTO

Tutti IC e parecchi semi-conduttori sono sensibili alle scariche statiche (ESD).

La loro longevità potrebbe essere fortemente ridotta in caso di non osservazione della più grande cauzione alla loro manipolazione.

Durante le riparazioni occorre quindi essere collegato allo stesso potenziale che quello della massa dell'apparecchio tramite un braccialetto a resistenza.

Assicurarsi che i componenti e anche gli utensili con quali si lavora siano anche a questo potenziale.

### GB

Safety regulations require that the set be restored to its original condition and that parts which are identical with those specified be used.

### NL

Veiligheidsbepalingen vereisen, dat het apparaat in zijn oorspronkelijke toestand wordt terug gebracht en dat onderdelen, identiek aan de gespecificeerde worden toegepast.

### D

Bei jeder Reparatur sind die geltenden Sicherheitsvorschriften zu beachten. Der Originalzustand des Gerats darf nicht verändert werden. Für Reparaturen sind Original-Ersatzteile zu verwenden.

### I

Le norme di sicurezza esigono che l'apparecchio venga rimesso nelle condizioni originali e che siano utilizzati pezzi di ricambio identici a quelli specificati.

### F

Les normes de sécurité exigent que l'appareil soit remis à l'état d'origine et que soient utilisées les pièces de rechange identiques à celles spécifiées.

### SHOCK, FIRE HAZARD SERVICE TEST:

**CAUTION:** After servicing this appliance and prior to returning to customer, measure the resistance between either primary AC cord connector pins (with unit NOT connected to AC mains and its Power switch ON), and the face or Front Panel of product and controls and chassis bottom,

Any resistance measurement less than 1 Megohms should cause unit to be repaired or corrected before AC power is applied, and verified before return to user/customer.

Ref. UL Standard NO. 1492.

### NOTE ON SAFETY:

Symbol : Fire or electrical shock hazard. Only original parts should be used to replace any part with symbol Any other component substitution (other than original type), may increase risk of fire or electrical shock hazard.

## LASER SAFETY

This unit employs a laser. Only a qualified service person should remove the cover or attempt to service this device, due to possible eye injury.

### LASER DEVICE UNIT

Type:	SemiconductorlaserGaAIAs
Wave length:	650 nm (DVD) 780 nm (VCD/CD)
Output Power:	7 mW (DVD) 10 mW (VCD/CD)
Beam divergence:	60 degree



**USE OF CONTROLS OR ADJUSTMENTS OR PERFORMANCE OF PROCEDURE OTHER THAN THOSE SPECIFIED HEREIN MAY RESULT IN HAZARDOUS RADIATION EXPOSURE.**

### AVOID DIRECT EXPOSURE TO BEAM

### WARNING

The use of optical instruments with this product will increase eye hazard.  
Repair handling should take place as much as possible with a disc loaded inside the player

### WARNING LOCATION: INSIDE ON LASER COVERSIELD

**CAUTION** VISIBLE AND INVISIBLE LASER RADIATION WHEN OPEN AVOID EXPOSURE TO BEAM  
**ADVARSEL** SYNLIG OG USYNLIG LASERSTRÅLING VED ÅBNING UNDGÅ UDSÆTTELSE FOR STRÅLING  
**ADVARSEL** SYNLIG OG USYNLIG LASERSTRÅLING NÅR DEKSEL ÅPNES UNNGÅ EKSPONERING FOR STRÅLEN  
**VARNING** SYNLIG OCH OSYNLIG LASERSTRÅLNING NÅR DENNA DEL ÅR ÖPPNAD BETRakta EJ STRÅLEN  
**VARO!** AVATT AESSA OLET ALTTIINA NÄKYVÄLLE JA NÄKYMÄTTÖMÄLLE LASER SÄTEILYLLE. ÄLÄ KAT SO SÄTEESEEN  
**VORSICHT** SICHTBARE UND UNSICHTBARE LASERSTRAHLUNG WENN ABDECKUNG GEÖFFNET NICHT DEM STRAHL AUSSETZEN  
**DANGER** VISIBLE AND INVISIBLE LASER RADIATION WHEN OPEN AVOID DIRECT EXPOSURE TO BEAM  
**ATTENTION** RAYONNEMENT LASER VISIBLE ET INVISIBLE EN CAS D'OUVERTURE EXPOSITION DANGEREUSE AU FAISCEAU

## Warning for powersupply on position 1005

**The primary side of the powersupply including the heatsink carries live mains voltage when the player is connected to the mains even when the player is switched off !**

This primary area is not shielded so it is possible to touch copper tracks and/or components when servicing the player. Service personnel have to take precautions to prevent touching this area or components in this area .

The primary side of the powersupply has been indicated with a lightning stroke and a stripe-marked printed on the printed wiring board

## 2.1 Notes

### 2.1.1 DVD-Module

For repair of the DVD-module ASD1, the service manual 3122 785 10840 has to be used.

### 2.1.2 Compair

For assistance with the repair process of the monoboard an electronic Fault finding guidance has been developed , this program is called COMPAIR.

This COMPAIR program is available on CDROM.

The Version of the CDROM for repair of the monoboard is V1.3 and can be ordered with codenumber : 4822 727 21637. This is an update CDROM , so when the COMPAIR CDROM is used for the first time , one has to install the COMPAIR ENGINE CDROM V1.2 first.

The V1.2 CDROM can be ordered with codenumber 4822 727 634 and has to registered after installation , the procedure for registration is explained in the help file of the program and in the booklet from the CDROM.

The cable to connect the monoboard with a PC can be ordered with codenumber 3122 785 90017.

All the hardware and software requirements of the systems necessary for working with COMPAIR is described on the CDROM.

## 3. Directions for use

### General Information



The region code for this set is 4.

Since it is usual for DVD movies to be released at different times in different regions of the world, all players have region codes and discs can have an optional region code. If you load a disc of a different region code to your player, you will see the region code notice on the screen. The disc will not play and should be unloaded.

**NOTE:**  
**PICTURES SHOWN MAYBE DIFFERENT BETWEEN COUNTRIES.**

**NEVER MAKE OR CHANGE CONNECTIONS WITH THE POWER SWITCHED ON.**

**CAUTION**  
**VISIBLE AND INVISIBLE LASER RADIATION WHEN OPEN AVOID EXPOSURE TO BEAM (WARNING LOCATION: INSIDE ON LASER COVERSHELD OR THE BACKPLATE OF SET)**

#### LASER SAFETY

This unit employs a laser. Due to possible eye injury, only a qualified service person should remove the cover or attempt to service this device.

**USE OF CONTROLS OR ADJUSTMENTS OR PERFORMANCE OF PROCEDURES OTHER THAN THOSE SPECIFIED HEREIN MAY RESULT IN HAZARDOUS RADIATION EXPOSURE.**

#### LASER

Type	Semiconductor laser GaAlAs
Wave length	650 nm (DVD) 780 nm (VCD/CD)
Output Power	7 mW (DVD) 10 mW (VCD/CD)
Beam divergence	60 degree

Manufactured under license from Dolby Laboratories. "Dolby" and the double-D symbol are trademarks of Dolby Laboratories. Confidential Unpublished Works. ©1992-1997 Dolby Laboratories, Inc. All rights reserved.

This product incorporates copyright protection technology that is protected by method claims of certain U.S. patents and other intellectual property rights owned by Macrovision Corporation and other rights owners. Use of this copyright protection technology must be authorized by Macrovision Corporation, and is intended for home and other limited viewing uses only unless otherwise authorized by Macrovision Corporation. Reverse engineering or disassembly is prohibited.

For Customer Use:

Read carefully the information located at the bottom of your DVD-VIDEO player and enter below the Serial No. Retain this information for future reference.

Model No. DVD-VIDEO 703

Serial No. \_\_\_\_\_

#### 2 GENERAL INFORMATION



DVD Video Player



PHILIPS

Let's make things better.

TruSurround and the SRS symbol are trademarks of SRS Labs., Inc. TruSurround technology is manufactured under license from SRS Labs., Inc.

**TruSurround™**  
by **SRS** (SRS logo)

Manufactured under license from Digital Theater Systems, Inc. US Pat. No. 5,451,942 and other world-wide patents issued and pending. "DTS" and "DTS DIGITAL SURROUND" are trademarks of Digital Theater Systems, Inc. © 1996 Digital Theater Systems, Inc. All rights reserved.

# Contents

<b>Introduction</b>	
Philips DVD-Video Introduction	4
Unpacking	4
Remote Control battery installation	4
Safety Information	4
Cleaning Discs	4
<b>Functional Overview</b>	
Front and Rear Panels	5
Remote Control	6
<b>Preparation</b>	
General Notes	7
Connecting to a TV	7
Connecting to Optional Equipment	7-8
NTSC/PAL Settings	8
General Explanation	8
Menu Bar/Status Window	9
Temporary Feedback Field Icons	9
Personal Preferences	9-10
<b>Operation</b>	
Loading Discs	11
Playing a DVD-Video and Video CD	11
General Features	11-13
Special DVD features	13
Special Video CD & SVCD features	14
Playing an Audio CD	14-15
Favorite Track Selection (FTS) Program	15
<b>Access Control</b>	
Access Control: Child Lock	16
Access Control: Parental Control	16-17
<b>Before Requesting Service</b>	
Before Requesting Service	18
<b>Specifications</b>	
Specifications	19

# Introduction

## Philips DVD-Video Introduction

Your Philips DVD-Video player will play digital video discs conforming to the universal DVD-Video standard. With it, you will be able to enjoy full-length movies with true cinema picture quality, as well as stereo or multi-channel sound (depending on the disc, and your playback setup). The unique features on DVD-Video, such as selection of sound track, subtitle languages and different camera angles (again depending on the disc), are all supported. In addition to DVD-Video discs, you will be able to play all Video CDs and Audio CDs (including finalized CD Recordable and CD Rewritable).

### DVD-Video

You will recognize DVD-Video discs by the logo shown. Depending on the material on the disc (a movie, video clips, a drama series, etc.), the disc may have one or more Titles.

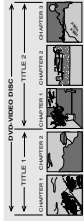

### Video CD

You will recognize Video CDs by the logo shown.



### Super-VCD (SVCD)

SVCD discs based on the Super-VCD IO Standard referring to Standard of Electronics Industry of the People's Republic of China.

### Audio CD

Audio CDs contain music tracks only. You will recognize Audio CDs by the logo shown.



## Unpacking

First, check and identify the contents of your DVD-Video player package. You should have the following items.

- DVD-Video player
- Remote Control with batteries
- Audio cable
- Video cable
- Instructions for use

If any item is damaged or missing, contact your retailer or Philips. Keep the packaging material for future transportation.

## Remote Control Battery Installation

- Insert batteries as indicated inside the battery compartment.

**Caution: Do not mix old and new batteries. Never mix different types of batteries (standard, alkaline, etc.).**

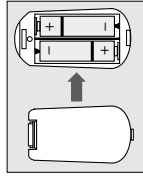

## Safety Information

- Do not expose the system to excessive moisture, rain, sand, or heat sources.
- Place the player on a firm, flat surface.
- Keep the player away from domestic heating equipment and direct sunlight.
- In a cabinet, allow about 2.5 cm (1 inch) of free space all around the Player for adequate ventilation.
- If the DVD-Video player cannot read CD/DVDs correctly, use a commonly available cleaning CD/DVD to clean the lens before taking the DVD-Video player to be repaired.
- Other cleaning methods may destroy the lens. Always keep the tray closed to avoid dust on the lens.
- The lens may cloud over when the DVD-Video player is suddenly moved from cold to warm surroundings. Playing a CD/DVD is not possible then. Leave the power on for about one hour with no disc in the unit until normal playback is possible.

## Cleaning Discs

- When a disc becomes dirty, clean it with a cleaning cloth.
- Wipe the disc from the center out, in a straight line.
- Do not use solvents such as benzine, thinner, commercially available cleaners, or anti-static spray intended for analog discs.

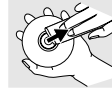

# Functional Overview

## Front and Rear Panels

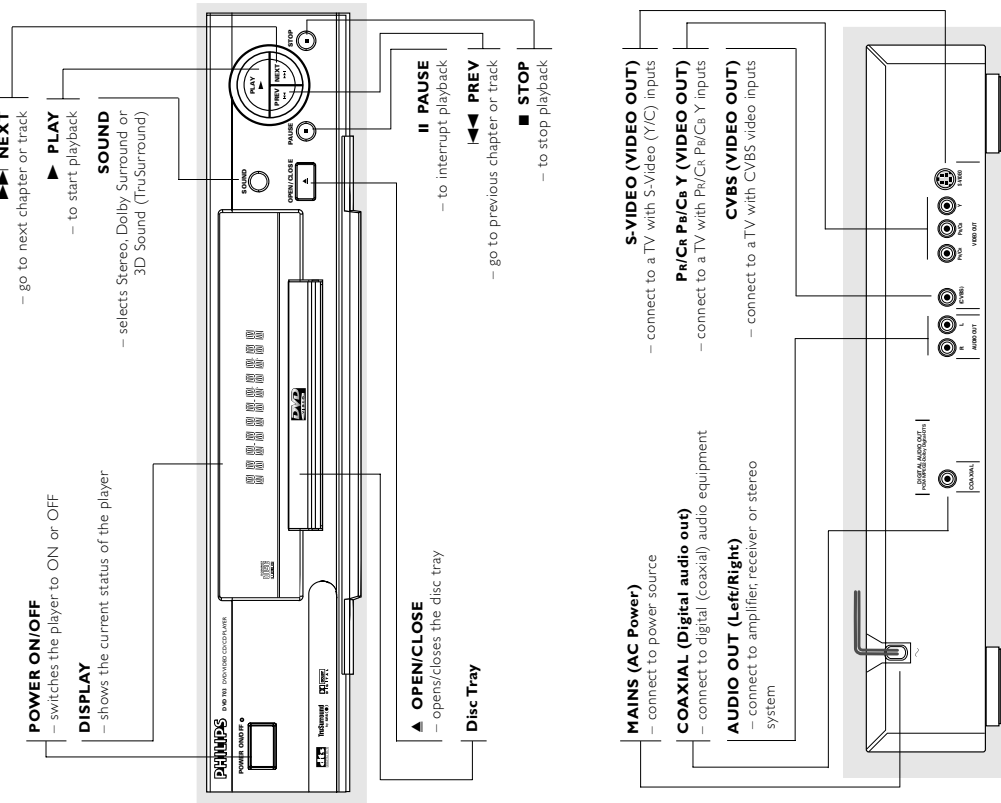

Caution: Do not touch the inner pins of the jacks on the rear panel. Electrostatic discharge may cause permanent damage to the unit.

## Remote Control

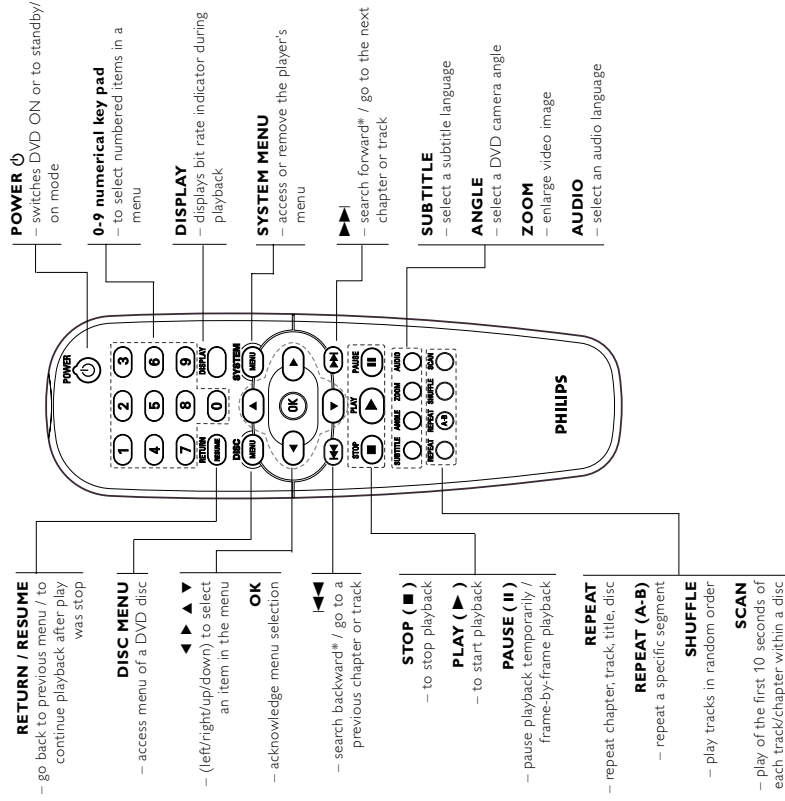

\* Press and hold key for about two seconds



## Preparation

### General Notes

- Depending on your TV and other equipment you wish to connect, there are various ways you could connect the player. Use only one of the connections described below. Please refer to the manuals of your TV/VCR, Stereo System or other devices as necessary to make the best connections.
- For better sound reproduction, connect the player's audio out jacks to the audio in jacks of your amplifier/receiver, stereo or audio/video equipment. See 'Connecting to optional equipment'.

#### Caution:

- Make sure the DVD player is connected directly to the TV. Set the TV to the correct video input channel.
- Do not connect the player's audio out jack to the phono in jack of your audio system.
- Do not connect your DVD player to the TV via your VCR. The DVD image could be distorted by the copy protection system.

### Connecting to a TV

- Make one of the following connections, depending on the capabilities of your existing equipment.

#### Component Video (Pr/Cr Pb/Cb Y) connection

- Connect the Pr/Cr, Pb/Cb, Y video out jacks on the DVD player to the corresponding in jacks on the TV, using an optional Pr/Cr, Pb/Cb, Y cable (Z).
- Connect the Left and Right audio out jacks of the DVD player to the audio left/right in jacks on the TV (A).

#### S-Video (Y/C) connection

- Connect the S-Video video out jack on the DVD player to the S-Video in jack on the TV using an optional S-Video cable (Y).
- Connect the Left and Right audio out jacks of the DVD player to the audio left/right in jacks on the TV (A).

#### CVBS connection

- Connect the CVBS video out jack on the DVD player to the video in jack on the TV using the video cable supplied (X).
- Connect the Left and Right audio out jacks to the audio left/right in jacks on the TV (A).

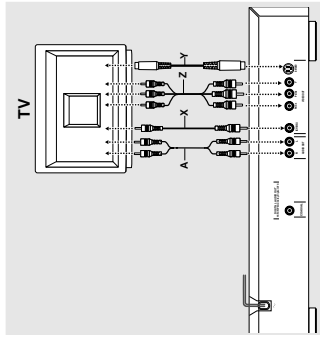

### Connecting to Optional Equipment

#### Connecting to an amplifier equipped with two channel analog stereo or Dolby Surround

- Connect the Left and Right audio out jacks of the DVD player to the audio left and right in jacks on your amplifier, receiver or stereo system, using the supplied audio cable (A).

#### Connecting to an amplifier equipped with two channel digital stereo (PCM) or to an Audio/Video receiver equipped with a multi-channel decoder (Dolby Digital™, MPEG 2 or DTS)

- Connect the player's coaxial digital audio out jack to the corresponding coaxial digital audio in on your amplifier. Use an optional digital audio cable (F).
- You will need to activate the player's digital output (see 'Personal Preferences').

#### Digital Multi-channel sound

The digital multi-channel connection provides the best sound quality. For this you need a multi-channel Audio/Video receiver that supports one or more of the audio formats supported by your DVD player (MPEG 2, Dolby Digital™ or DTS). Check the receiver manual and the logos on the front of the receiver.

## General explanation

### About this manual

This manual gives the basic instructions for operating the DVD player. Some DVDs require specific operation or allow only limited operation during playback. When this occurs, the symbol appears on the TV screen, indicating that the operation is not permitted by the player or the disc.

### Remote control operation

- Unless stated, all operations can be performed by the remote control. Always point the remote control directly at the player, making sure there are no obstructions between the remote and the player. Corresponding keys on the front panel of the player can also be used.

### Menu bar operation

- A number of operations can be done with the menu bar on the screen. The menu bar can be accessed by pressing the cursor keys on the remote control.
- Pressing SYSTEM MENU while the menu bar is displayed will clear the menu bar from the screen.
- The selected item will be highlighted, and the appropriate cursor keys to operate it will be displayed below the icon.
- The symbols < or > indicates that more items are available at the left/right of the menu bar. Press or to select these items.

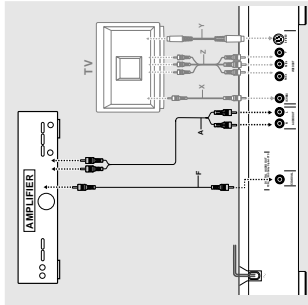

#### Note:

- If the audio format of the digital output does not match the capabilities of your receiver, the receiver will produce a strong distorted sound or no sound at all.
- Six Channel Digital Surround Sound via digital connection can only be obtained if your receiver has a Digital Multi-channel decoder.
- To see the selected audio format of the current DVD in the Status Window, press SYSTEM MENU or Audio.

### NTSC/PAL Settings

You can switch the NTSC/PAL setting of the DVD player to match the video signal of your TV. This setting only affects the television's on-screen display that shows the stop and setup modes. You may select either NTSC or PAL. To change the DVD player setting to PAL or NTSC, follow the steps below.

- Press the POWER ON/OFF button on the front panel of the DVD player to turn OFF the DVD player.
- Press and hold and on the front of the DVD player. While holding and , press POWER ON/OFF.
- After PAL or NTSC appears on the display panel of the DVD player, release and at the same time. The PAL or NTSC indicator that appears on the display panel indicates the current setting.
- To change the setting, press within three seconds. The new setting (PAL or NTSC) will appear on the display panel.

**Menu Bar/Status Window**

As there are multiple menu bars, the items on the menu bar are arranged according to usage and availability of direct access keys. Pressing the SYSTEM MENU keys repeatedly will toggle through menu bar 1, menu bar 2, menu bar 3 and OFF.

Menu bar 1

- Personal Preferences
- Subtitle Language
- Audio Language
- Color
- Sound

Menu bar 2

- Step by step playback
- Slow motion
- Fast motion
- Angle
- Zoom

Menu bar 3

- Title
- Chapter
- Time Search
- Favorite Track Selection (FTS)

**Temporary Feedback Field Icons**

- scan
- repeat
- title
- track
- chapter
- shuffle
- shuffle
- repeat A to end
- repeat A-B
- angle
- reset
- safe
- resume
- action prohibited

**Personal Preferences**

You can set your own personal preferences on the player.

**General operation:**

- Press SYSTEM MENU on the remote control.
- Select in the menu bar.
- The Personal Preferences menu appears.
- Use the keys to toggle through the menus, submenus and submenu options.
- When a menu item is selected, the cursor keys (on the remote control) to operate the item are displayed next to the item.
- Press OK to confirm and return to the main menu.
- The following items can be adapted:

**Picture**

**TV Shape**

If you have a wide screen (16:9) TV, select 16:9. If you have a regular (4:3) TV, select 4:3. If you have a 4:3 TV, you can also select between: Letterbox for a wide-screen picture with black bars at the top and bottom of the screen, or Pan Scan, for a full-height picture with the sides trimmed. If a disc supports the format, the picture will be shown accordingly.

**Black level shift (NTSC users only)**

Select ON for adapting the color dynamics to obtain richer contrasts.



**Video shift**

The factory centers the video on your TV screen. Use this setting to personalize the position of the picture on your TV by moving it to the left or right.



**Sound**

**Digital output**

Factory setting: ALL. This means coaxial output is on. If you are not connecting equipment with a digital input, change the setting to OFF. If your equipment doesn't include a digital multi-channel decoder, set the digital output to PCM only (Pulse Code Modulation).



**Analog output**

Select Stereo, Dolby Surround or 3D Sound (True Surround) to match your system's playback capability.



**Night Mode**

Optimizes the dynamics of the sound for low volume playback.

**Karaoke vocal**

Put this setting to ON only when a multi-channel karaoke DVD is being played. The karaoke channels on the disc will then be mixed into a normal stereo sound.

**Language**

Select the required Menu, Audio and Subtitle language. Audio language and Subtitle language can also be adapted using the Menu bar.

**Features**

**Access Control**

Access Control contains the following features: Child Lock - When Child Lock is set to ON, a 4-digit code must be entered in order to play discs. Parental control - Allows the conditional viewing of DVDs containing Parental Control Information (see Access Control).

**Status Window**

Displays the current status of the player and is displayed with the menu bar. When disc playback is stopped, it is displayed with the Temporary Feedback Field in the default screen. See 'On-Screen Display' information. The factory setting is ON. Select OFF to suppress display of the Status Window.



**Bit Rate Indicator**

When activated, the bit rate for video and audio, as well as the total bit rate is displayed. This is only applicable during playback of DVD and SVCD discs.



**Help text**

When set to ON, help text describes the icons selected. Select OFF if you no longer require the help text.

**Personal Preferences**

You can set your own personal preferences on the player.

**General operation:**

- Press SYSTEM MENU on the remote control.
- Select in the menu bar.
- The Personal Preferences menu appears.
- Use the keys to toggle through the menus, submenus and submenu options.
- When a menu item is selected, the cursor keys (on the remote control) to operate the item are displayed next to the item.
- Press OK to confirm and return to the main menu.
- The following items can be adapted:

**Picture**

**TV Shape**

If you have a wide screen (16:9) TV, select 16:9. If you have a regular (4:3) TV, select 4:3. If you have a 4:3 TV, you can also select between: Letterbox for a wide-screen picture with black bars at the top and bottom of the screen, or Pan Scan, for a full-height picture with the sides trimmed. If a disc supports the format, the picture will be shown accordingly.

**Black level shift (NTSC users only)**

Select ON for adapting the color dynamics to obtain richer contrasts.



**Video shift**

The factory centers the video on your TV screen. Use this setting to personalize the position of the picture on your TV by moving it to the left or right.



**Sound**

**Digital output**

Factory setting: ALL. This means coaxial output is on. If you are not connecting equipment with a digital input, change the setting to OFF. If your equipment doesn't include a digital multi-channel decoder, set the digital output to PCM only (Pulse Code Modulation).



**Analog output**

Select Stereo, Dolby Surround or 3D Sound (True Surround) to match your system's playback capability.



**Night Mode**

Optimizes the dynamics of the sound for low volume playback.

**Karaoke vocal**

Put this setting to ON only when a multi-channel karaoke DVD is being played. The karaoke channels on the disc will then be mixed into a normal stereo sound.

**Language**

Select the required Menu, Audio and Subtitle language. Audio language and Subtitle language can also be adapted using the Menu bar.

# Operation

## Loading Discs

- 1 Press OPEN/CLOSE on the front of the player to open the disc tray.
- 2 Load your chosen disc in the tray, label side up.
- 3 Press OPEN/CLOSE again to close the tray.  
→ **REPT** appears in the status window and on the player display, and playback starts automatically.

**Note:**

- If 'Child Lock' is set to ON and the disc inserted is not authorized, the 4-digit code must be entered and/or the disc must be authorized (see 'Access Control').

## Playing a DVD-Video and Video CD

### Playing a disc

- After inserting the disc and closing the tray, playback starts automatically. The status window of the player display shows the type of disc loaded, as well as the disc's information and playing time.
- The disc may invite you to select an item from a menu. If the selections are numbered, press the appropriate numerical key; if not, use the **▶▶▶▶▶** keys to highlight your selection; then press OK.
- The number of the current title and chapter are displayed. Playback may stop at the end of the Title and you may return to the DVD disc menu. To go to the next title, press **▶▶▶▶▶**.
- To stop playback, press **■**.
- To the default screen will appear, giving information about the current status.
- You can resume playback from the point at which you stopped playback. Press **▶▶▶▶▶** when you see the Resume icon on the screen, press **▶▶▶▶▶** again.
- The RESUME feature applies not only to the disc in the player, but also to the last four discs you have played. Simply reload the disc and press **RESUME** on the remote control or press **▶▶▶▶▶** when you see the Resume icon **▶▶▶▶▶** on the screen, then press **▶▶▶▶▶** again.

**Note:**

- DVDs may have a region code. Your player will not play discs that have a region code different from the region code of your player.

## General Features

- Note:**
- Unless stated, all operations described are based on remote control use. Some operations can be carried out using the menu bar on the screen.



### Moving to another title/chapter

- When a disc has more than one title or chapter, you can move to another title/chapter as follows: Press **SYSTEM MENU**, then select **■** or **■** in the menu bar.
- Press **▶▶▶▶▶** or **▶▶▶▶▶** to select a title/chapter.

### Slow Motion

- Select **■** (SLOW MOTION) in the menu bar.
- Use the **▶▶▶▶▶** keys to enter the SLOW MOTION menu.
- The player will now go into PAUSE mode.
- Use the cursor keys **◀▶▶▶▶** to select the required speed: -1, -1/2, -1/4 or -1/8 (backward), or +1/8, +1/4, +1/2 or +1 (forward).
- Select 1 to play the disc at normal speed again.
- If **■** is pressed, the speed will be set to zero (PAUSE).
- To exit slow motion mode, press **▶▶▶▶▶** or **▶▶▶▶▶**.

### Still Picture and Frame-by-frame playback

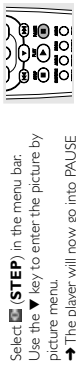

- Select **■** (STEP) in the menu bar.
- Use the **▶▶▶▶▶** key to enter the picture by picture menu.
- The player will now go into PAUSE mode.

- Use the cursor keys **◀▶▶▶▶** to select the previous or next picture frame.
- To exit **STEP** mode, press **▶▶▶▶▶** or **▶▶▶▶▶**.
- You can also step forward by pressing **■** repeatedly on the remote control.



### Scan

- Scanning plays the first 10 seconds of each chapter/index on the disc.
- Press **SCAN**.
- To continue playback at your chosen track, press **SCAN** again or press **▶▶▶▶▶**.

## Search

- Select **■** (FAST MOTION) in the menu bar.
- Use the **▶▶▶▶▶** keys to enter the FAST MOTION menu.
- Use the **◀▶▶▶▶** keys to select the required speed: -32, -8 or -4 (backward), or +4, +8, +32 (forward).
- Select 1 to play the disc at normal speed again.
- To exit FAST MOTION mode, press **▶▶▶▶▶** or **▶▶▶▶▶**.
- To search forward or backward through different speeds, you can also hold down **▶▶▶▶▶** or **▶▶▶▶▶**.

## Repeat



### DVD-Video Discs - Repeat chapter/ title/disc

- To repeat the currently playing chapter, press REPEAT.
- **→ REPEAT CHPT** appears on the player display.
- To repeat the title currently playing, press REPEAT a second time.
- **→ REPEAT TITL** appears on the display.
- To repeat the entire disc, press REPEAT a third time.
- **→ REPEAT** appears on the display.
- To exit Repeat mode, press REPEAT a fourth time.

### Video CDs - Repeat track/disc

- To repeat the track currently playing, press REPEAT.
- **→ REPEAT TRK** appears on the player display.
- To repeat the entire disc, press REPEAT a second time.
- **→ REPEAT** appears on the display and the screen.
- To exit Repeat mode, press REPEAT a third time.

## Repeat A-B

- To repeat a sequence in a title: Press REPEAT A-B at your chosen starting point.
- **▶▶▶▶▶** appears briefly on the screen.
- Press REPEAT A-B again at your chosen end point.
- **→ REPEAT A-B** appears briefly on the display, and the repeat sequence begins. (**REPEAT A-B** is displayed on the front panel of the player)
- To exit the sequence, press REPEAT A-B.

## Shuffle



### DVD-Video discs

- This shuffles the playing order of chapters within a title, if the title has more than one chapter.
- Press **SHUFFLE** during playback.
- **→ SHUFFLE** appears on the screen for about two seconds.
- To return to normal playback, press SHUFFLE again.

### Video CDs

- Press SHUFFLE during playback.
- **→ SHUFFLE** appears on the screen for about two seconds.
- To return to normal playback, press SHUFFLE again.

## Time search

- The Time Search function allows you to start playing at any chosen time on the disc.
- Select **■** (TIME SEARCH) in the menu bar.
- Press **▶▶▶▶▶**.
- The player will now go into PAUSE mode.
- A time edit box appears on the screen, showing the elapsed playing time of the current disc.
- Use the digit keys to enter the required start time. Enter hours, minutes and seconds from left to right in the box.
- Each time an item has been entered, the next item will be highlighted.
- Press OK to confirm the start time.
- The time edit box will disappear and playback starts from the selected time on the disc.



## Zoom

- The Zoom function allows you to enlarge the video image and to pan through the enlarged image.

### Select **■** (ZOOM)

- Press **▶▶▶▶▶** to activate the **ZOOM** function and select the required zoom factor: 1.33 or 2, or 4.
- The player will go into Pause mode.
- The selected zoom factor appears below the Zoom icon in the menu bar, and 'Press OK or pan' appears below the menu bar.

- The picture will change accordingly.

- Press OK to confirm the selection.
- The panning icons appear on the screen.
- Use the **◀▶▶▶▶** keys to pan across the screen.
- When OK is pressed only the zoomed picture will be shown on the screen.
- To exit **ZOOM** mode:
  - Press **▶▶▶▶▶** to resume playback.



### FTS-Video

- The FTS-Video function allows you to store your favorite titles and chapters (DVD) and favorite tracks and indexes (VCD) for a particular disc in the player memory.
- An programmed FTS will be placed on top of the list when playback is activated. When the list is full, a new program will replace the last program on the list.
- The program can be selected and played at any time.

### Storing an FTS-Video Program

- While playback is stopped, select **VIDEO FTS**  in the menu bar.
- Press **▼** to open the menu.
- **→** The **VIDEO FTS** menu appears.
- Press **▶** or **◀** or **FTS** to select **ON** or **OFF**.

### Storing titles/tracks

- Press **▼** to select **TITLES**
- Use **▶** and **◀** to select the required title.
- Press **OK** if you wish to store the entire title.
- **→** The title number will be added to the list of selections.



### Storing chapters/indexes

- Press **▼** on the selected title number.
- **→** The title number will be marked and the highlight moves to the first available chapter number for this title.
- Use **▶** and **◀** to select the required chapter number.
- Press **OK** to confirm the selection.
- **→** The title/chapter-selection will be added to the list of selections.
- Press **SYSTEM MENU** to exit the **VIDEO FTS**  menu.

### Erasing an FTS-Video Program

- While playback is stopped, select **VIDEO FTS**  in the menu bar.
- Use **▼** to select **PROGRAM**.
- Use **▶** and **◀** to select the required number.
- Press **OK** to erase the selection.
- Press **SYSTEM MENU** to exit.

### Erasing all selections

- While playback is stopped, select **VIDEO FTS**  in the menu bar.
- Use **▼** to select **CLEAR ALL**.
- Press **OK**.
- **→** All selections will be erased.
- Press **SYSTEM MENU** to exit.

## Special DVD Features

### Checking the contents of DVD-Video discs: Menus

DVDs may contain menus to navigate the disc and access special features. To use the menu, press the appropriate numerical key or use the **▼**, **▶**, **◀** keys to highlight your selection, then press **OK**.

### Title/Disc menu

- Press **DISC MENU**  **→** If the current title has a menu, the menu will appear on the screen. Otherwise, the disc menu will be displayed.
- The menu can list camera angles, spoken language and subtitle options, and chapters for the title.
- To remove the title menu, press **DISC MENU** again.

### Camera Angle

If the disc contains sequences recorded from different camera angles, the angle icon appears, showing the number of available angles and the angle being shown currently. You can then change the camera angle if you wish.

- Use the **▲▼** keys to select the required angle icon.
- **→** After a while, playback changes to the selected angle. The angle icon remains displayed until multiple angles are no longer available.



### Changing the audio language

- Select **(A) (AUDIO)** in the menu bar.
- Press **(A)** or **(A)▼** repeatedly to see the different languages.



### Subtitles

- Select **(S) (SUBTITLE)** in the menu bar.
- Press **(S)** or **(S)▼** repeatedly to see the different subtitles.



## Special Video CD & SVCD Features

### Playback Control (PBC)

- Load a Video CD with PBC and press **▶**.
- Go through the menu with the keys indicated on the TV screen until your chosen passage starts to play. If a **PBC** menu consists of a list of titles, you can select a title directly.
- Enter your choice with the numerical keys (0-9).
- Press **RETURN** to go back to the previous menu.
- You may also set to **PBC OFF** under Personal Preferences.

### Playing an Audio CD

- After loading the disc, playback starts automatically.
- If the TV is on, the Audio CD screen appears.
- The number of tracks and the total playing time of the disc will be shown on the screen.
- During playback, the current track number and its elapsed playing time will be shown on the screen and on the player display.
- Playback will stop at the end of the disc.
- To stop playback at any other time, press **■**.



### Pause

- Press **II** during playback.
- To return to playback, press **▶**.

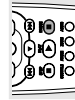

### Search

- To search forward or backward through the disc at four times normal speed, hold down **▶** or **◀** for about one second during playback.
- Search begins, and sound is partially muted.
- To step up to eight times the normal speed, press **▶▶** or **◀◀** again.
- Search goes to eight times the speed, and the sound is muted.
- To return to four times the normal speed, press **▶▶▶** or **◀◀◀** again.
- If the TV is on, search speed and direction are indicated on the screen each time **▶▶** or **◀◀** is pressed.
- To end the search, press **▶** to resume playback or press **■** to stop playback.



### Moving to another track

- Press **◀◀** or **▶▶** briefly during playback to go to the next track or to return to the beginning of the current track.
- Press **◀◀◀** twice briefly to step back to the previous track.
- To go directly to any track, enter the track number using the numerical keys (0-9).

### Shuffle

- Press **SHUFFLE** during playback.
- **→** The order of the tracks is changed.
- To return to normal playback, press **SHUFFLE** again.

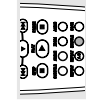

## Access Control

### Access Control: Child Lock (DVD-Video and Video CD)

#### Activating/deactivating the Child Lock

- 1 When disc playback is stopped, select **ACCESS CONTROL** in the features menu using the **▲▼** keys.
- 2 Enter a 4-digit code of your own choice.
- 3 Enter the code a second time.
- 4 Move to **"CHILD LOCK"** using the **▲▼** keys.
- 5 Move to **LOCK/UNLOCK** using the **▶** key.
- 6 Select **LOCK** using the **▲▼** keys.
- 7 Press **OK** or **◀** to confirm; then press **◀** again to exit the menu.
- 8 **UNLOCK** to deactivate the **CHILD LOCK**

- Note: Confirmation of the 4-digit code is necessary when:
  - The code is entered for the very first time (see above).
  - The code is changed (see "Changing the 4-digit code").
  - The code is cancelled (see "Changing the 4-digit code").



#### Authorizing discs

- Insert the disc. See "Loading disc".
  - The "child protect" dialog will appear.
  - Once "or Playback-Always" if you select "Playback Once", the disc can be played as long as it is in the player and the player is ON. If you select "Playback-Always", the disc will become child safe (authorized) and can always be played, even if the Child Lock is set to ON.

- Notes:
  - The player memory maintains a list of 120 authorized ("Child safe") disc titles. A disc will be placed in the list when "Playback-Always" is selected in the "child protect dialog".
  - Each time a child safe disc is played, it will be placed on top of the list. When the list is full and a new disc is added, the last disc in the list will be removed from the list.
  - Double-sided DVDs may have a different ID for each side. In order to make the disc "child safe", each side has to be authorized.
  - Multi-volume VCDs may have a different ID for each volume. In order to make the complete set "child safe", each volume has to be authorized.

### Favorite Track Selection (FTS) Program

- The FTS Program allows you to store your favorite tracks for a particular disc in the player memory.
- Each FTS Program can contain 20 tracks.



#### Storing an FTS Program

- 1 Load a disc and stop playback.
  - 2 Use **▼** to go to the list of available tracks.
  - 3 Use **▶** or **◀** to select tracks from the list.
  - 4 To go directly to any track, enter the track number using the numerical keys (0-9).
- The track numbers will be added to the list
- The number of tracks and the playing time of the program will be shown on the screen and the player display

When your FTS Program is complete, press **▶** to start playback or press **▲** to go back to Stop mode. In either case, the FTS Program will be automatically memorized.

#### Switching FTS ON/OFF

- 1 Use **▲▼** to move to select desired tracks.
- 2 Use **▶** or **◀** to select either ON or OFF.

#### Erasing a track from an FTS Program

- 1 Use **▼** to go to the list of selected tracks.
  - 2 Use **▶** and **◀** to select the track number you wish to erase.
  - 3 Press **OK**.
- The track number will be erased from the list of selected tracks.

#### Erasing the complete program

- 1 Use **▼** to select **CLEAR ALL**, then press **OK**.
- The complete FTS Program for the disc will be erased.

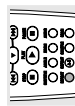

- To repeat the track currently playing, press **REPEAT**.
- **→ REPEAT TRK** appears on the display.
- To repeat the entire disc, press **REPEAT** a second time.
- **→ REPEAT** appears on the display.
- To exit Repeat mode, press **REPEAT** a third time.



- To repeat a sequence: Press **REPEAT A-B** at your chosen starting point.
- **→ A-** appears on the player display.
- Press **REPEAT A-B** again at your chosen end point.
- **→ A-B** appears on the display, and the sequence begins to play repeatedly.
- To exit the sequence, press **REPEAT A-B** again.



- Scanning plays the first 10 seconds of each track on the disc.
- Press **SCAN**.
- To continue playback at your chosen track, press **SCAN** again or press **▶**.



#### Deauthorizing discs

- Insert the disc. See "Loading disc".
  - Playback starts automatically.
- Press **■** while **Ⓢ** is visible.
- **→** The **Ⓢ** will appear and the disc is now deauthorized.

### Access Control: Parental Control (DVD-Video only)

Movies on DVDs may contain scenes not suitable for children. Therefore, discs may contain 'Parental Control' information which applies to the complete disc, or to certain scenes on the disc. These scenes are rated from 1 to 8, and alternative, more suitable scenes are available on the disc. Ratings are country dependent. The 'Parental Control' feature allows you to prevent discs from being played by your children or to have certain discs played with alternative scenes.



## Before Requesting Service

If it appears that the DVD-Video player is faulty, first consult this checklist. Something may have been overlooked. Under no circumstances should you attempt to repair the system yourself; this will invalidate the warranty.

Look for the specific symptom(s). Then perform only the actions listed to remedy the specific symptom(s).

Symptom	Remedy
<b>No power</b>	<ul style="list-style-type: none"> <li>Make sure the mains cord (AC Power) is properly connected.</li> <li>Check, if there is power at the AC outlet by plugging in another appliance.</li> </ul>
<b>No picture</b>	<ul style="list-style-type: none"> <li>Check if the TV is switched on.</li> <li>Check the video connection.</li> </ul>
<b>Distorted picture</b>	<ul style="list-style-type: none"> <li>Check the disc for fingerprints and clean the disc with a soft cloth, wiping from the center to the edge in a straight line.</li> <li>Sometimes a small amount of picture distortion may appear. This is not a malfunction.</li> </ul>
<b>Completely distorted picture or no color, with player menu</b>	<ul style="list-style-type: none"> <li>If the picture is distorted completely or if the picture rolls vertically, make sure the NTSC/PAL setting at the DVD player matches the video signal of your television.</li> <li>If your TV video signal is NTSC, select the NTSC setting at the DVD player.</li> <li>If your video signal is PAL, select the PAL setting. - See NTSC/PAL SETTINGS.</li> </ul>
<b>Distorted or black/white picture with DVD or Video CD</b>	<ul style="list-style-type: none"> <li>The disc format does not match your TV's video signal (PAL/NTSC).</li> </ul>
<b>No sound</b>	<ul style="list-style-type: none"> <li>Check audio connections.</li> <li>If you are using a HiFi amplifier, try another sound source.</li> </ul>
<b>Distorted sound from HiFi amplifier</b>	<ul style="list-style-type: none"> <li>Check to make sure that no audio connections are made to the amplifier's phono input.</li> </ul>
<b>No audio at digital output</b>	<ul style="list-style-type: none"> <li>Check the digital connections.</li> <li>Check the settings menu to make sure the digital output is set to ALL or PCM.</li> <li>Check, if the audio format of the selected audio language matches your receiver capabilities.</li> </ul>
<b>Disc can't be played</b>	<ul style="list-style-type: none"> <li>Ensure the disc label is facing up.</li> <li>Clean the disc.</li> <li>Check, if the disc is defective by trying another disc.</li> <li>Check to see if the disc is defective, badly scratched or warped (not flat).</li> </ul>
<b>No return to start-up screen when disc is removed</b>	<ul style="list-style-type: none"> <li>Reset by switching the player off, then on again.</li> <li>Check to see if the program requires another disc to be loaded.</li> </ul>
<b>The player does not respond to the remote control</b>	<ul style="list-style-type: none"> <li>Aim the remote control directly at the sensor on the front of the player.</li> <li>Remove any obstacles between the player and the remote control.</li> <li>Inspect or replace the batteries in the remote control.</li> </ul>
<b>Buttons do not work</b>	<ul style="list-style-type: none"> <li>In order to completely reset the player, unplug the AC cord from the AC outlet. (Please ensure that the set is not in Initial Setup mode)</li> </ul>
<b>Player does not respond to some operating commands during playback</b>	<ul style="list-style-type: none"> <li>Operations may not be permitted by the disc. Refer to the instructions of the disc.</li> </ul>
<b>DVD-Video player cannot read CDs/DVDs</b>	<ul style="list-style-type: none"> <li>Use a commonly available cleaning CD/DVD to clean the lens before sending the DVD-Video player for repair.</li> </ul>

### Changing the 4-digit code

- When disc playback is stopped, select **ACCESS CONTROL** in the features menu using the **▲▼** keys.
- Enter the old code.
- Move to **CHANGE CODE** using the **▼** key.
- Press the **►** key.
- Enter the new 4-digit code.
- Enter the code a second time and reconfirm by pressing **OK**.
- Press **◀** to exit the menu.

### If you forget your 4 digit code

- Press **■** to exit the 'Child Protect' screen.
- Select **ACCESS CONTROL** in the features menu using the **▲▼** keys.
- The 4-digit code can be cancelled by pressing **■** four times in the 'Access Control' dialog.
- You can then enter a new code (twice) as described above (Changing the 4 digit code).

### Parental Control Disclaimer

This DVD player features the **PARENTAL CONTROL** system which is intended to activate when playing DVD discs furnished with certain software coding. This is according to technical standards adopted by the set maker and disc content industries. Please note that the **PARENTAL CONTROL** system will not operate a DVD disc which is not furnished with the appropriate software coding. Also note that at the time of release of this DVD player, certain aspects of the technical standards had not been settled between set makers and the disc industries. On this basis, Philips cannot guarantee the functioning of the **PARENTAL CONTROL** system and denies any liability associated with unintended watching of disc content.

If in doubt, please make sure the disc plays according to your **PARENTAL CONTROL** settings before you allow children access to the player.

### Activating/Deactivating Parental Control

- When disc playback is stopped, select **ACCESS CONTROL** in the features menu using the **▲▼** keys.
- Enter your 4-digit code. If necessary, enter the code a second time.
- Move to **Parental Control** using the **▲▼** keys.
- Move to **VALUE ADJUSTMENT** (1-8) using the **►** key. Then use the **▲▼** keys or the numerical keys on the remote control to select a rating from 1 to 8 for the disc inserted.

**Rating 0 (displayed as "-"):**  
Parental Control is not activated. The Disc will be played in full.

**Ratings 1 to 8:**  
The disc contains scenes not suitable for children; if you set a rating for the player, all scenes with the same rating or lower will be played. Higher rated scenes will not be played unless an alternative is available on the disc. The alternative must have the same rating or a lower one. If no suitable alternative is found, playback will stop and the 4-digit code has to be entered.

- Press **OK** or **◀** to confirm, then press **◀** again to exit the menu.



### Country

- When disc playback is stopped, select **ACCESS CONTROL** in the features menu using the **▲▼** keys.
- Enter the 4-digit code.
- Move to **CHANGE COUNTRY** using the **▼** key.
- Press the **►** key.
- Select a country using **▲▼**.
- Press **OK** or **◀** to confirm, then press **◀** again to exit the menu.

# 4. Mechanical instructions

## 4.1 Dismantling instructions

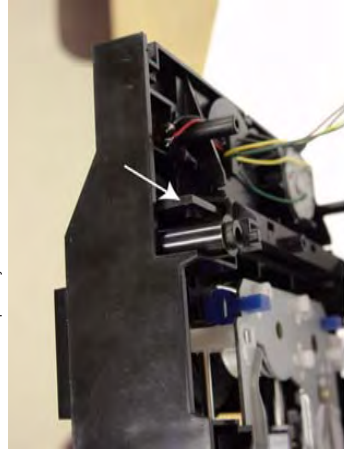
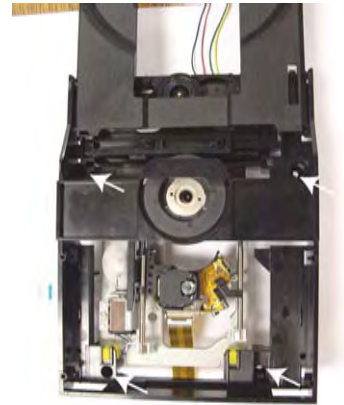
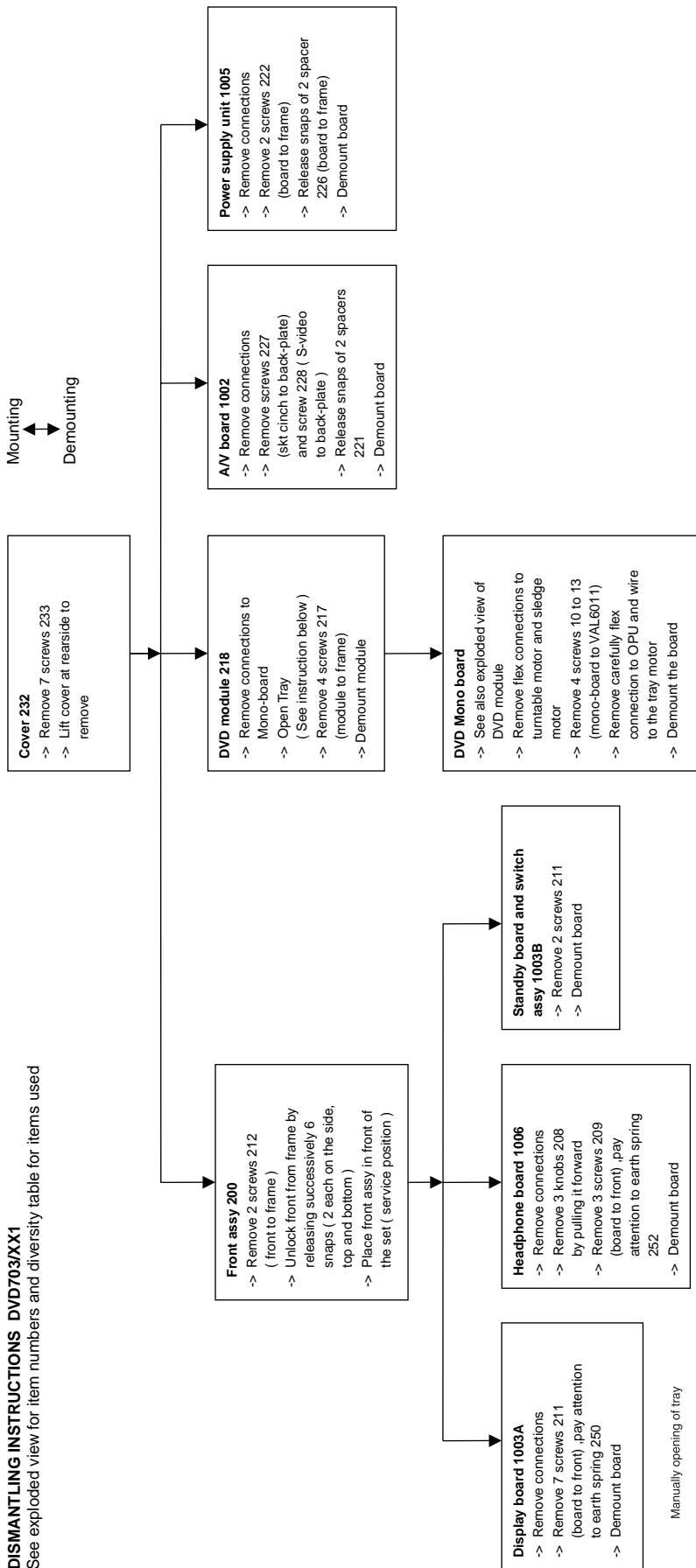

4.2 Exploded views

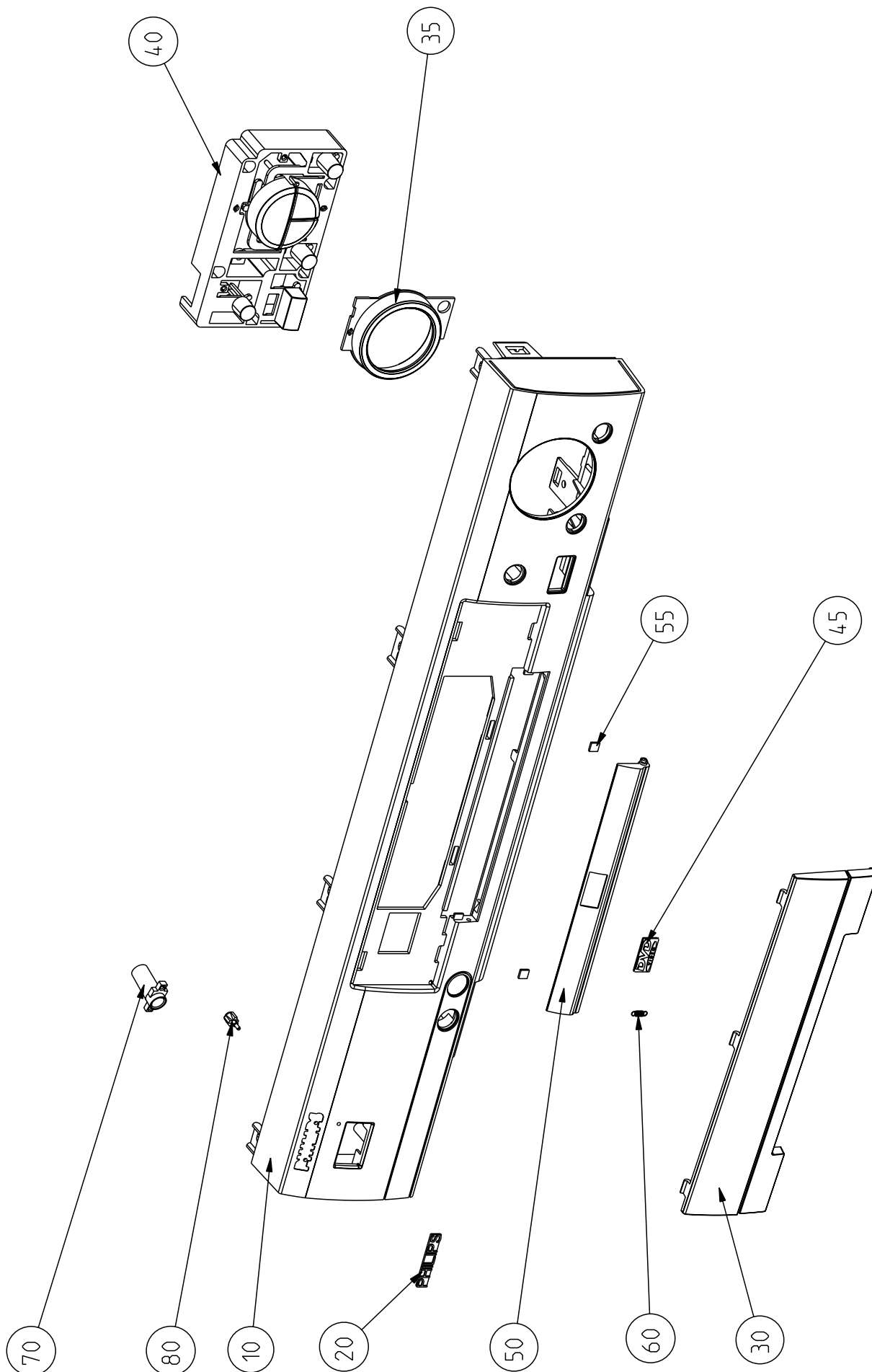

CL 16532007\_029\_095  
020201

Item number correspond to part list



ITEM	252	208	209	227	1006
MODEL					
DVD703 US/AP/LA	--	--	--	6X	--
DVD712 US/AP/LA	--	--	--	6x	--
DVD762 US	--	--	--	6X	--
DVD733K	1X	3X	3X	8X	1X

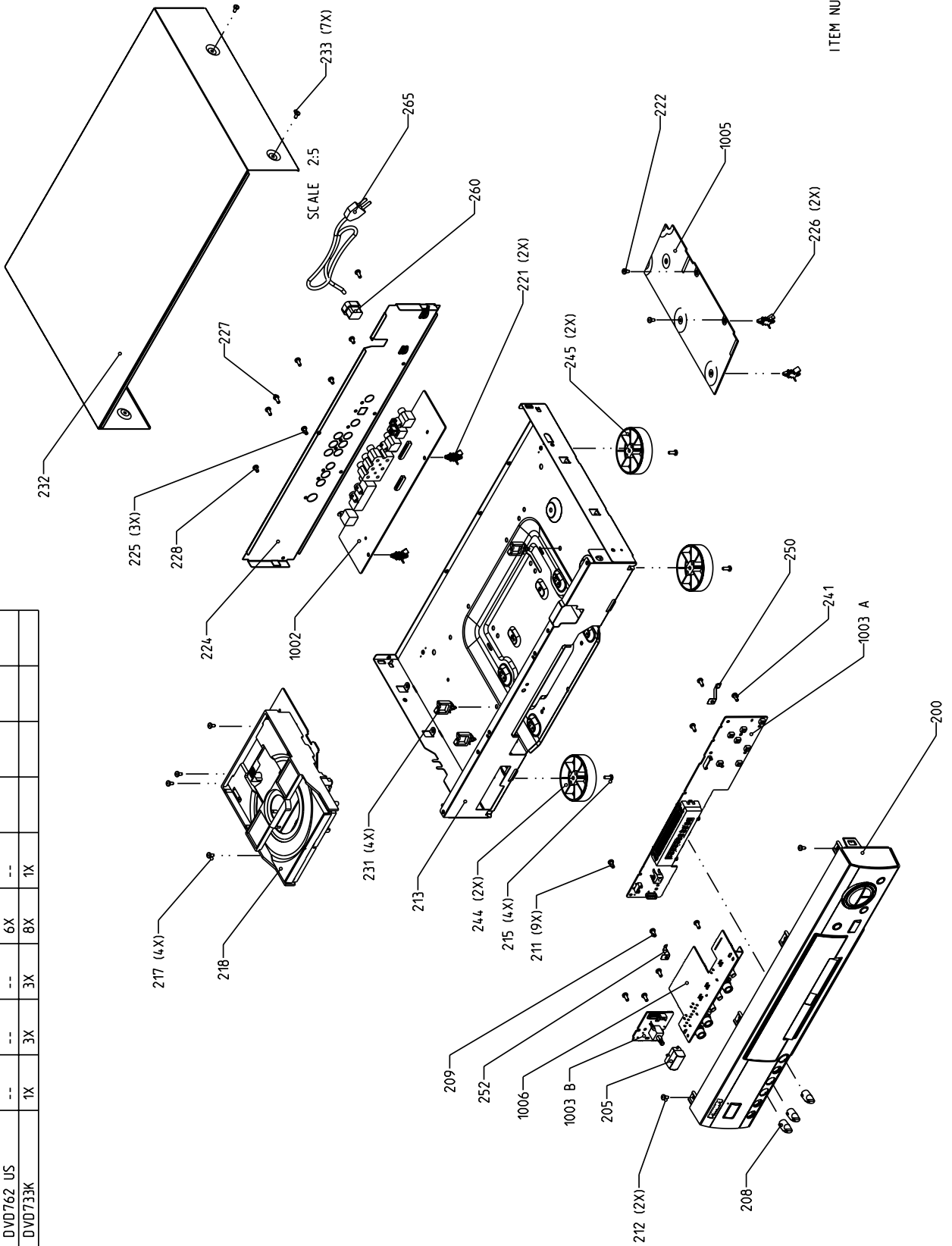

ITEM NUMBER CORRESPOND TO PART LIST

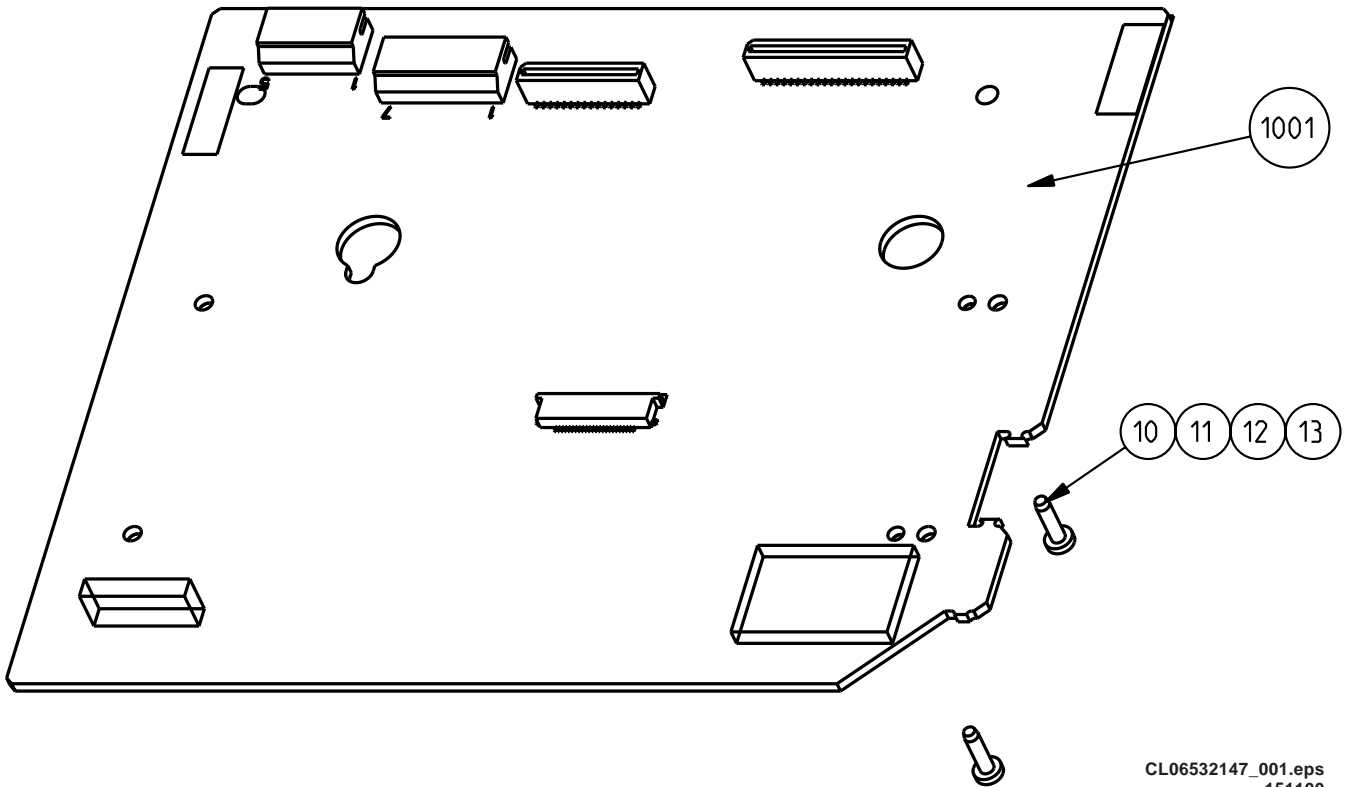
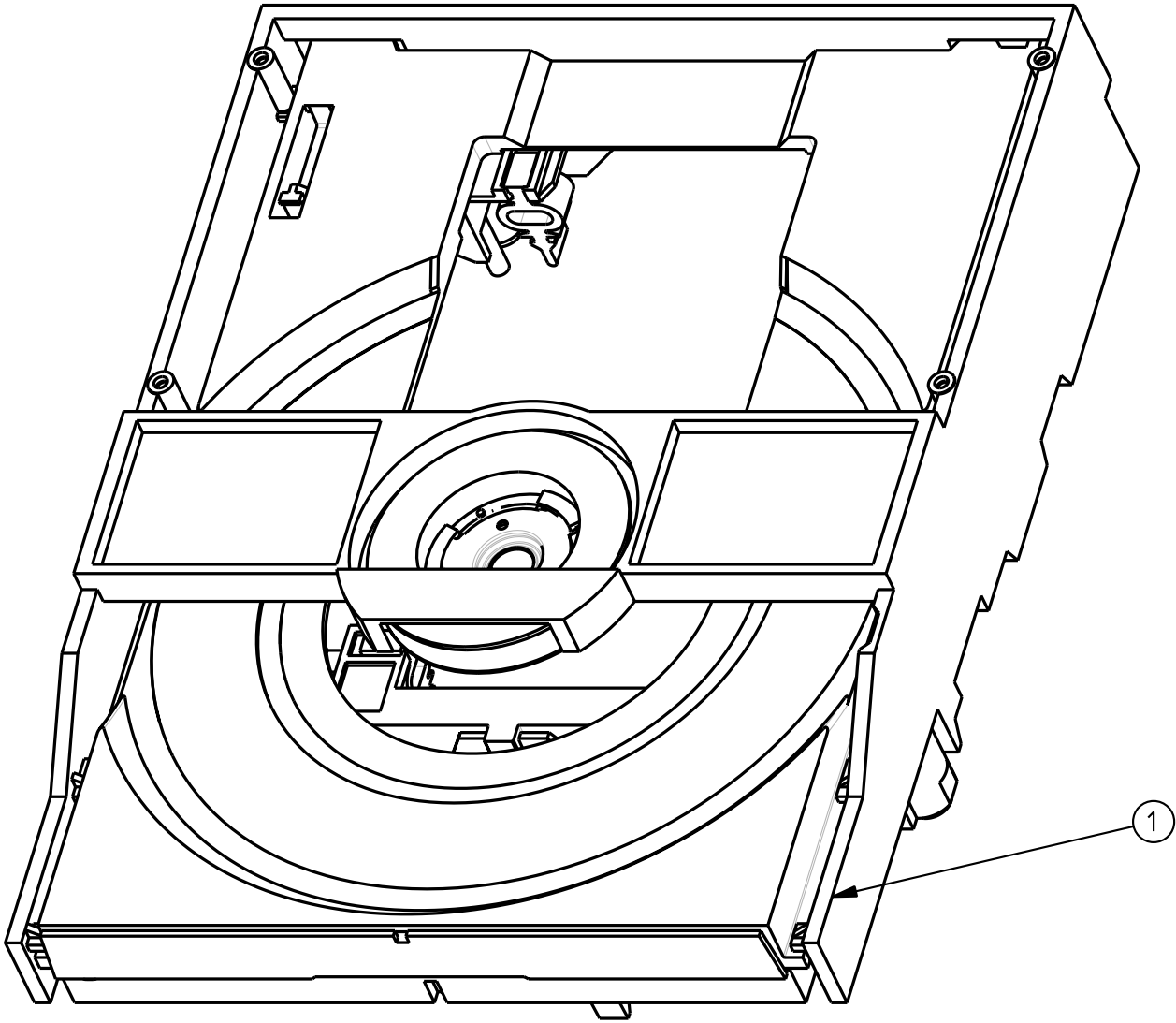

### 4.3 Service position

See figure 4-1 for the service position

1. Remove the cables from the cable tie housing.
2. Remove 4 screws that mount the DVD module to the bottom frame.
3. Move the DVD module backward slightly and flip the module over, so that the component side of the board faces upwards, and the module is in the service position.

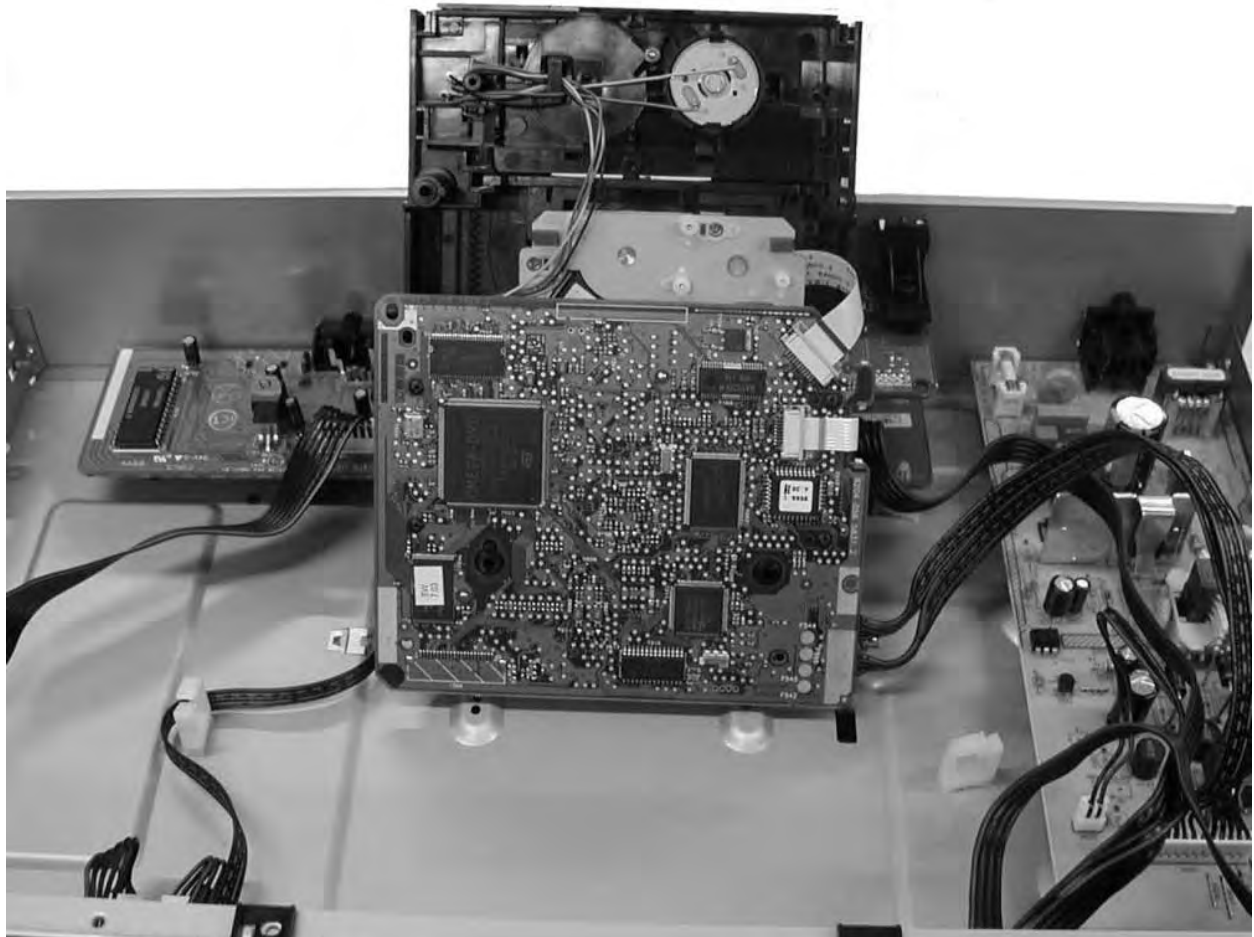

Figure 4-1

## 5. Diagnostic software descriptions and troubleshooting

### 5.1 Dealerscript

#### 5.1.2 Contents of Dealer Script

##### 5.1.1 Purpose of Dealer Script

The dealer script can give a diagnosis on a standalone DVD player; no other equipment is needed to perform a number of hardware tests to check if the DVD player is faulty. The diagnosis is simply a "error" or "pass" message; no indication is given of faulty hardware modules. Only tests within the scope of the diagnostic software will be executed hence only faults within this scope can be detected.

The dealer script executes all diagnostic nuclei that do not need any user interaction and are meaningful on a standalone DVD player.

The nuclei called in the dealer script are the following (the number after each nucleus name corresponds with the number being on the local display when the nucleus is executed during the dealer script):

Nucleus		Description
VideoColSetupComm	7	Checks the I2C interface with the RGB video processor on the Audio/Video board (only for DVD players with RGB video processor).
PapChksFl	6	Calculate and verify checksum of FLASH memory.
PapI2cDisp	5	Checks the I2C interface with the slave processor on the display PCB.
PapS2bEcho	4	Checks the I2C interface to the basic engine.
PapI2cNvram	3	Checks the I2C interface with the NVRAM.
PapNvramWrR	2	Pattern test of all locations in the NVRAM
CompSdramWrR	1	Pattern test of all locations in the SDRAM(s).

CL06532096\_001.eps  
050700

Figure 5-1

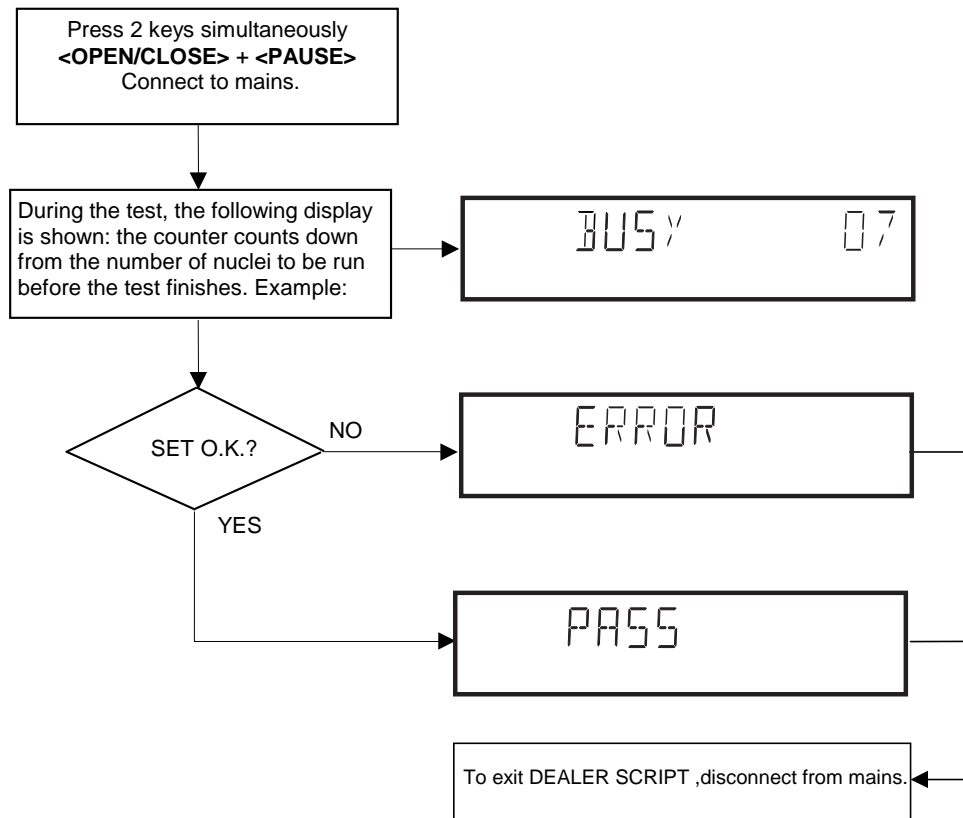

CL 96532065\_004.eps  
120799

Figure 5-2

## 5.2 PLAYER SCRIPT

### 5.2.1 Purpose of Player Script

The Player script will give the opportunity to perform a test that will determine which of the DVD player's modules are faulty, to read the error log and error bits and to perform an endurance loop test. To successfully perform the tests, the DVD player must be connected to a tv set to check the output of a number of nuclei. For DVDv2b a multi-channel amplifier, a set of 6 boxes and an external video source are necessary to test. To be able to check results of certain nuclei, the player script expects some interaction of the user (i.e. to approve a test picture or a test sound). Some nuclei (e.g. nuclei that test functionality of the Basic Engine module) require that the DVD player itself is opened, to enable the user to observe moving parts and approve their movement visually. Only tests within the scope of the diagnostic software will be executed hence only faults within this scope can be detected.

### 5.2.2 Contents of Player Script

The player script contains all nuclei that are useful on a DVD player that is connected to a tv-set and help to determine which module of the DVD player is faulty, as well as to read out the contents of the error logs.

### 5.2.3 Structure of Player Script

The player script consists of a set of nuclei testing the three hardware modules in the DVD player: the Display PWB, the Digital PWB and the Basic Engine.

Nuclei run by the player test need some user interaction; in the next paragraph this interaction is described. The player test is done in two phases:

1. Interactive tests: this part of the player test depends strongly on user interaction and input to determine nucleus results and to progress through the full test. Reading the error log and error bits information can be useful to determine any errors that occurred recently during normal operation of the DVD player.
2. The loop test will loop through the list of nuclei indefinitely, till the NEXT key is pressed. The list of nuclei is as follows:
  - VideoColSetupComm
  - VideoScartSwComm
  - PapChksFlash
  - Papl2cNvram
  - CompSdramWrR
  - PapS2bEcho
  - Papl2cDisp

For DSW version 1.6 and above. the DSW version number will be displayed on the local display. Press NEXT to continue to the display test.

The display should look like the following:



CL 16532007\_002.eps  
010201

Figure 5-3

### 5.2.4 Survey

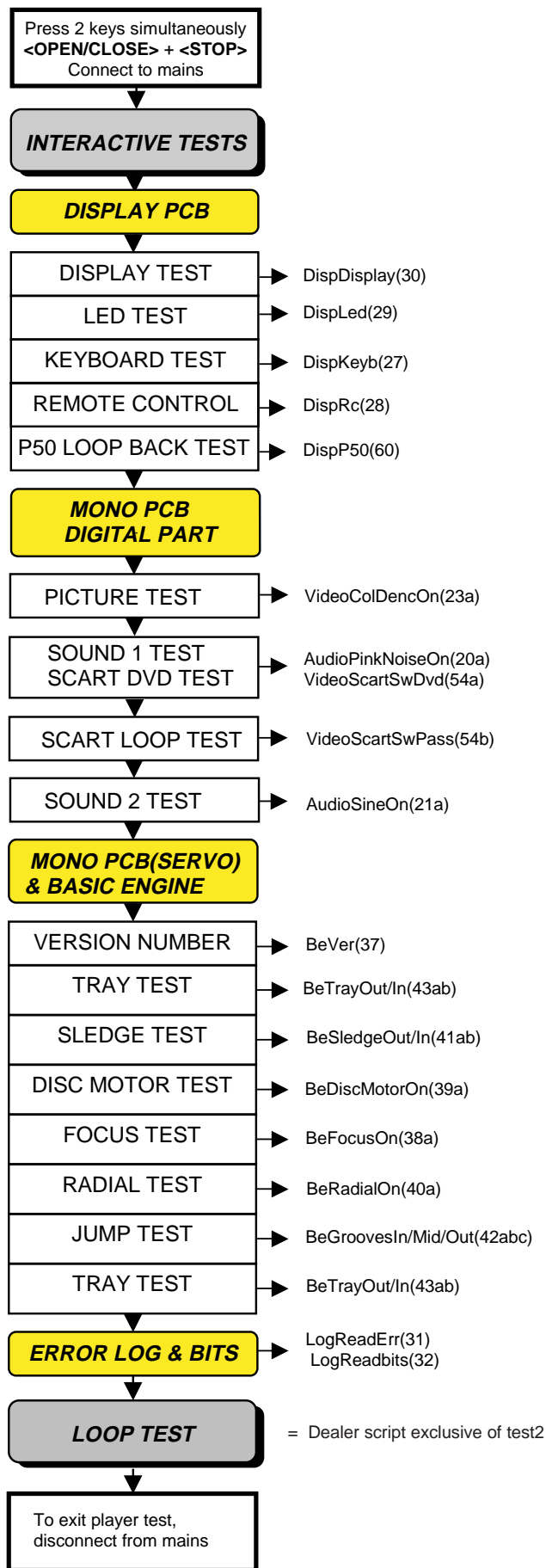

CL 16532007\_003.eps  
300101

Figure 5-4

5.3 DISPLAY PCB

5.3.1 DISPLAY TEST

The display test is performed by nucleus DispDisplay. By putting a series of test patterns on the local display, the local display is tested. To step through all different patterns, the user must either press PLAY (pattern is ok) or PAUSE (pattern was incorrect) to proceed to the next pattern. The display of patterns is continued in a cyclic manner until the user presses NEXT. If the user presses NEXT before all display patterns are tested, the DispDisplay nucleus will return TRUE (display test successful).

5.3.2 LED TEST

The LED(s) on the DVD player is (are) tested by nucleus DispLed. The user must check if the LED(s) is (are) lighted; if it is, press PLAY, if it is not, press PAUSE. By pressing NEXT the script will proceed to the next test. If the user presses NEXT before PLAY or PAUSE, the DispLed nucleus will return TRUE (LED test successful).

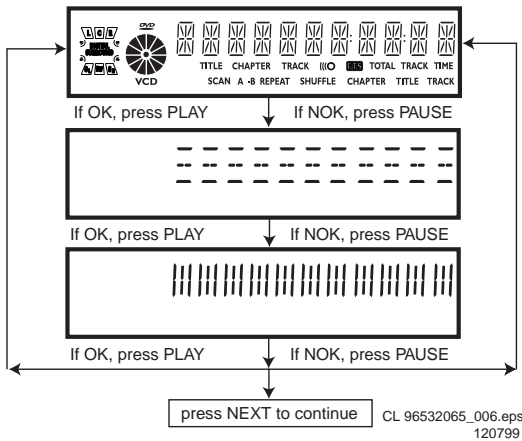

Figure 5-5

5.3.3 KEYBOARD TEST

The keyboard of the DVD player is tested by nucleus DispKeyb. The user is expected to press all keys on the local keyboard once. The code of the key pressed is shown on the local display (1 hexadecimal digit) immediately followed by a (hexadecimal) number indicating how many times that key has been pressed. Example of the local display during this test:

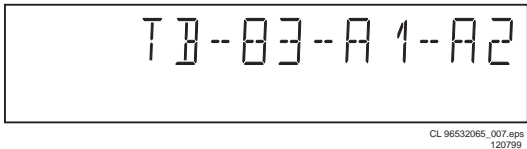

Figure 5-6

The key-codes displayed on the local display will scroll from right to left when the display gets full, the text "tb-" will remain on display.

key id.	key
0	PLAY
1	NEXT
2	PREVIOUS
3	PAUSE
4	STOP
5	OPEN/CLOSE
6	3D-SURROUND
7	KEY- (Mic Control)
8	Once More (Mic Control)
9	KEY+(Mic Control)
A	STAND BY

CL16532007\_007.eps  
300101

Figure 5-7

If any keys are detected more than once (due to hardware error), the key-code is displayed twice (or more), with the second digit increased by 1. If the user does not press all keys minimally once (in any order), the DispKeys nucleus will return FALSE and cause an error in the overall result of the player script. The test will also pass if all buttons, except the microphone key buttons, are pressed. The user can leave the keyboard test by pressing the NEXT key on the local display of the DVD player for at least one full second. The result of the keyboard test is shown on local display as follows:

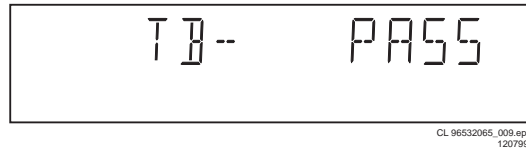

Figure 5-8

Or

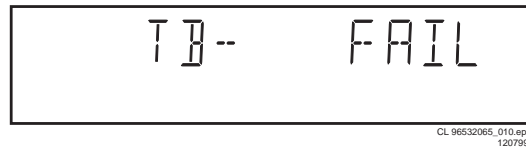

Figure 5-9

Pressing NEXT on the local keyboard again will proceed to the next text.

5.3.4 REMOTE CONTROL TEST

The remote control of the DVD player is tested by nucleus DispRc. The user must press any key on the remote control just once. The codes of the key pressed will be shown on the local display in hexadecimal format. Example:

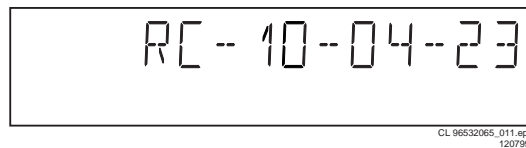

Figure 5-10

In this example 23 is the hexadecimal code of the pressed RC key. The user can leave the remote-control test by pressing NEXT on the local keyboard of the DVD player. The remote

control test is successful if a code was received before the user pressed the NEXT key; pressing the NEXT key before pressing a key on the remote control gives an error in the remote control test (note that the remote control test will also fail if a key on the remote control was pressed but no code was received). The remote control test does not check upon the contents of the received code, that is it will not be checked if the received code matches the key pressed. If desired, the user can manually check this code by using a code-table for the remote control key-codes.

C Key id	Hexadecimal code
STANDBY	0C
STOP	31
PLAY	2C
PLAY BACKWARD	2D
PAUSE	30
STEP FORWARD	F6
STEP BACKWARD	F5
FORWARD	28
FORWARD 4X	DF
FORWARD 8X	E0
BACKWARD	29
BACKWARD 4X	DE
BACKWARD 8X	DD
SLOW	22
SLOW 2	D9
SLOW BACKWARD	23
SLOW BACKWARD 2	DA
NEXT	20
PREVIOUS	21
CURSOR UP	58
CURSOR DOWN	59
CURSOR LEFT	5A
CURSOR RIGHT	5B
OK	5C
0	0
1	1
2	2
3	3
4	4
5	5
6	6
7	7
8	8
9	9
TOGGLE	C8
ANGLE	85
AUDIO	4E
SUBTITLES	4B
SUBTITLE ON/OFF	E3
ROOT MENU	54
TITLE MENU	71
MENU	D1
SETUP MENU	82
OSD ON/OFF	F
RETURN	83
RESUME	D7
SCAN	2A
SHUFFLE	1C
REPEAT	1D
A/B REPEAT	3B
TOGGLE SCART	43
OPEN/CLOSE	42
FTS	FB
KARAOKE	E4
OPTION	FA

CL06532096\_003.eps  
050700

Figure 5-11

After pressing NEXT, the result of the remote control test is displayed on the local display of the DVD player as follows:

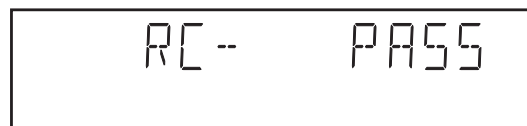

CL 96532065\_013.eps  
120799

Figure 5-12

Or

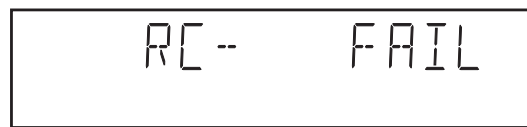

CL 96532065\_014.eps  
120799

Figure 5-13

Pressing NEXT on the local keyboard again will proceed to the next test.

### 5.3.5 P50 LOOP-BACK TEST

For the P50 loop-back test, the user must first press a key to decide if the test is to be performed.

The display will show the following message:



CL 16532007\_004.eps  
010201

Figure 5-14

If the user presses PAUSE, the P50 test will be skipped. If the user presses PLAY, the P50 test is performed and the result is displayed as follows:

Test successful:



CL 16532007\_005.eps  
010201

Figure 5-15

Test fails:

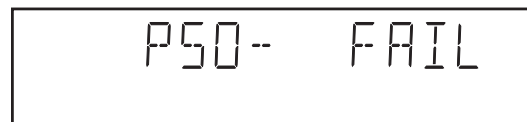

CL 16532007\_006.eps  
010201

Figure 5-16

Press the NEXT key to continue to the next test

## 5.4 MONO PCB DIGITAL PART

### 5.4.1 PICTURE TEST

The picture test is performed by putting a predefined picture (colour bar) on the display (nucleus VideoColDencOn) and

asking the user for confirmation. The display will show the following message:

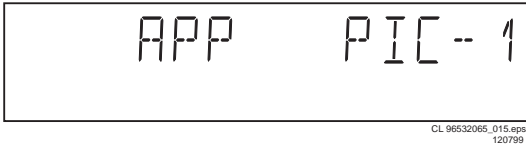

Figure 5-17

By pressing PLAY the user confirms the test, pressing PAUSE will indicate the picture was invisible or incorrect. Pressing NEXT will proceed to the next test

#### 5.4.2 SOUND 1 & SCART DVD TEST

The first soundtest is performed by starting a pink noise sound that needs confirmation from the user (nucleus AudioPinkNoiseOn); the display will show the following message very shortly:

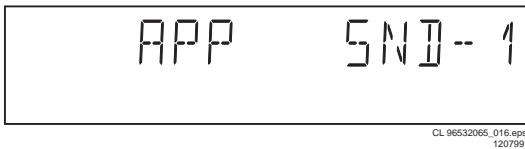

Figure 5-18

This sound will only be audible from version cut3.1 of Sti5505(item7503 on mono board) onwards. After starting up sound 1, SCART loop-trough will be simultaneously active during this test. SCART loop-trough will be measured with the aid of an external video source. When entering the SCART loop-trough, the local display indicates:

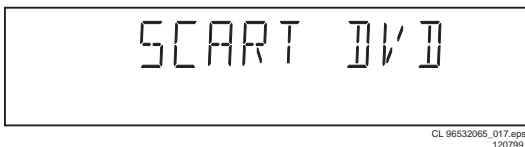

Figure 5-19

On the TV screen a colour bar (generated by nucleus VideoColDencOn) is visual and the internally generated pinknoise is audible. By pressing PLAY the user confirms the test, pressing PAUSE will indicate the sound was inaudible or incorrect. Pressing NEXT will proceed to the next test; if the user presses NEXT without pressing PLAY or PAUSE first, the result of this test will be TRUE (sound ok). By pressing the NEXT button there will be switched over to the external source, this must become now visible on the TV screen (using the SCART). The local display indicates:



Figure 5-20

The internally generated colour bar is still available on the CVBS and Y/C outputs. And the pinknoise-signal is still available on the cinch audio outputs. By pressing the PREV button, the internal generated colour bar becomes visual again.

The test can be left by pressing the NEXT key for more than one second.

#### 5.4.3 SOUND 2 TEST

The second soundtest is performed by producing a sine sound (nucleus AudioSineOn). The signal can be stopped by pressing the STOP-key. The display will show the following message:

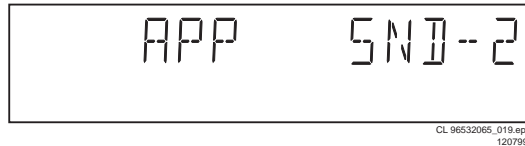

Figure 5-21

By pressing PLAY the user confirms the test, pressing PAUSE will indicate that something went wrong. Pressing NEXT will proceed to the next; if the user presses NEXT without pressing PLAY or PAUSE first, the result of this test will be TRUE (sound ok).

#### 5.4.4 Colour setup test

The colour setup test is performed by putting the internally generated colour bar in different settings on the TV screen. The first colour bar will be displayed in setting 1. the display will show the following message:



Figure 5-22

By pressing the NEXT button, you can go to the second setting. The local display indicates:



Figure 5-23

By pressing the PREVIOUS button, the colour bar with the first setting becomes visual again.

By pressing PLAY the user confirms the test, pressing PAUSE will indicate that something went wrong. The test can be left by pressing the NEXT key for more than one second; if the user presses NEXT without pressing PLAY or PAUSE first, the result of the test will be TRUE (colour set-up ok).

### 5.5 BASIC ENGINE

#### 5.5.1 VERSION NUMBER

In the basic engine tests, the version number of the Basic Engine will be shown first, as the following example:



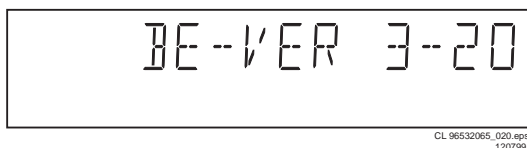

Figure 5-24

By pressing the NEXT key, the Basic Engine tests are started.

### 5.5.2 TRAY TEST

First, the tray is tested. The purpose of this test is also to give the user the opportunity to put a disc in the tray of the DVD player. Some tests on the Basic Engine require that a disc (e.g. DVD MPTD test disc) is present in the player. At the end of the Basic Engine tests this tray test will be repeated solely to enable the user to remove the disc in the tray. The local display will look as follows:

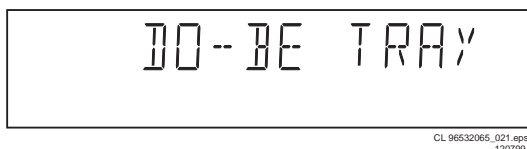

Figure 5-25

By pressing PLAY or PAUSE the user can toggle the position of the tray. Note that this test will not contribute to the test result of the Basic Engine. Pressing NEXT will proceed to the next test, after the tray has been closed (by the software) if it was open.

### 5.5.3 SLEDGE TEST(visual test)

The second Basic Engine test tests the sledge; the user can move the sledge as many times as desired by using PLAY (nucleus BeSledgeOut) and PAUSE (nucleus BeSledgeln). Pressing NEXT on the local keyboard proceeds to the next test. Note that this test will not contribute to the test result of the Basic Engine. The local display will look as follows during the sledge test:

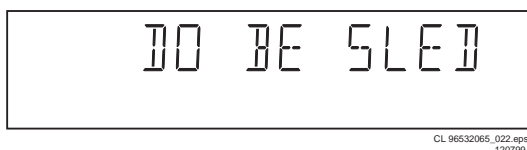

Figure 5-26

### 5.5.4 DISC MOTOR TEST(visual test)

The third Basic Engine test tests the disc motor (nucleus BeDiscMotorOn); the local display looks as follows:

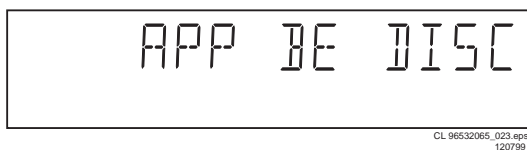

Figure 5-27

By pressing PLAY the user confirms that the disc motor is running; pressing PAUSE indicates the disc motor does not work. Pressing NEXT proceeds to the next test, after a reset

of the disc motor (nucleus BeDiscMotorOff). If the user presses NEXT before pressing PLAY or PAUSE, the result of this test will be TRUE (disc motor is running).

### 5.5.5 FOCUS TEST(visual test)

The fourth Basic Engine test tests the focussing; first focussing is turned on by calling nucleus BeFocusOn. The display will look as follows:

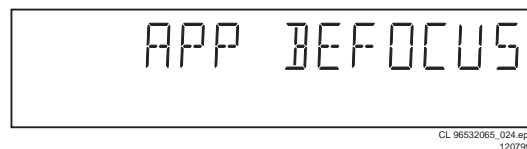

Figure 5-28

By pressing PLAY the user confirms that the focussing was successful; pressing PAUSE indicates a focussing failure. Pressing NEXT proceeds to the next test after a reset of the focussing (nucleus BeFocusOff); if NEXT is pressed before PLAY or PAUSE, the result of this test will be TRUE (focus successful).

### 5.5.6 RADIAL TEST(visual & listening test)

The fifth Basic Engine test tests the radial functionality (nucleus BeRadialOn); the local display looks as follows:

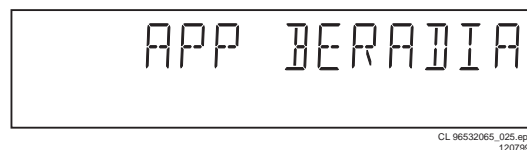

Figure 5-29

By pressing PLAY the user confirms that the radial function worked; pressing PAUSE indicates the function does not work. Pressing NEXT proceeds to the next test, after a reset of the radial (nucleus BeRadialOff). If the user presses NEXT before pressing PLAY or PAUSE, the result of this test will be TRUE (radial successful).

### 5.5.7 JUMP TEST(listening test)

The sixth and last Basic Engine test tests the jumping by calling nuclei BeGroovesIn, BeGroovesMid and BeGroovesOut. During this test, the local display looks as follows:

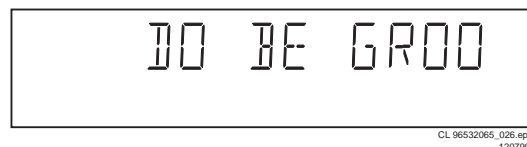

Figure 5-30

The user can switch between the three different types of groove settings by pressing PLAY (forward to next nucleus in the list In-Mid-Out) or PAUSE (backward in the list In-Mid-Out). This is done in a cyclic manner; note that this test will not contribute to the test result of the Basic Engine. Pressing NEXT proceeds to the next test, after the disc motor has been shut off with a call to nucleus BeDiscMotorOff.

5.5.8 TRAY TEST

As a last action for the Basic Engine tests, the tray test is repeated. The local display will look as follows:

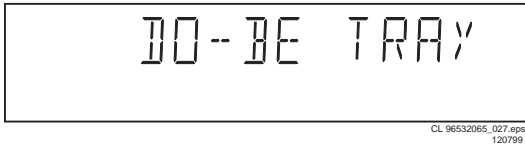

Figure 5-31

This test is meant to give the user the opportunity to remove the disc in the tray. The tray position can be toggled using the PLAY and PAUSE key. The tray will be closed (by the software, if it is open) before proceeding to the next test when the user presses the NEXT key.

5.5.9 ERROR LOG (see table on page 30)

Reading the error log and error bits information can be useful to determine any errors that occurred recently during normal operation of the DVD player. Reading the error log is done by nucleus LogReadErr. The display during the errorlog readout looks as follows :

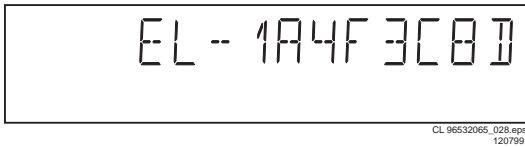

Figure 5-32

By pressing PLAY or PAUSE the user can move forward or backward (respectively) through the logged error codes. The highlighted number indicates which errorcode is currently on display (in the example above, errorcode number 4 is displayed). If "0000" is displayed at all positions, the error log is empty. Display of the logged errors is done in a cyclic manner. The errorcode with the lowest highlighted number is the most recent. By pressing NEXT on the local keyboard, the user can proceed to the next test.

5.5.10 ERROR BITS (see table on page 30)

Reading the error bits is done by nucleus LogReadBits. The display during the errorbits readout looks as follows:

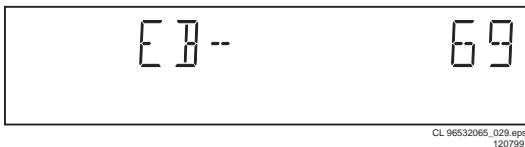

Figure 5-33

Only the set errorbits will be shown by their (decimal) number. Refer to the appropriate documentation for the explanation of each bit number. If the display only shows "EB-0", no error bits were set. By pressing NEXT the user can continue to the next test.

5.6 LOOP TEST (see table below)

At the start of the loop test, the display will show the result of the interactive player test:

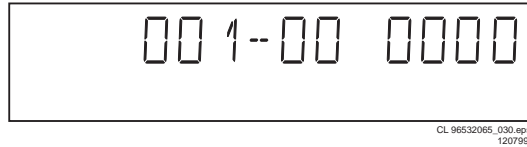

Figure 5-34

The left side of the display contains a 3-digit code, which can have a value between 000 and 111. These values are to be interpreted as follows:

Displayed Value	Indication for each module		
	Basic Engine	Mono PCB	Display PCB
000	ok	ok	ok
001	ok	ok	faulty
010	ok	faulty	ok
011	ok	faulty	faulty
100	faulty	ok	ok
101	faulty	ok	faulty
110	faulty	faulty	ok
111	faulty	faulty	faulty

Figure 5-35

The loop test will perform the same nuclei as the dealer test, but it will loop through the list of nuclei indefinitely. The display of the DVD player will display not only the three digits indicating correct/faulty modules and the last found error code (as mentioned, faults are detected as far as they can be within the scope of the diagnostic software), but also a loop counter indicating how many times the loop has been gone through. Example:

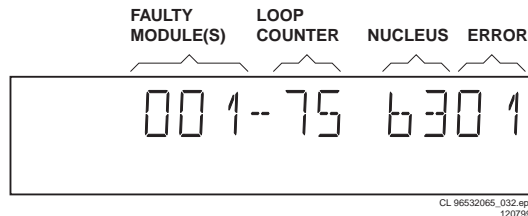

Figure 5-36

The number after the hyphen indicates the number of times the loop test has been performed; the 4 digits at the right side of the display show the last error that was found when running the loop test: the leftmost two digits of this code indicate which nucleus resulted in a fault; the rightmost two digits refer to the faultcode within that nucleus. For further explanation of this error code, see list of error codes below.

## ERROR CODES LOOP TEST

ERROR CODE	NUCLEUS NUMBER	ERROR DESCRIPTION
0601	6	Calculated checksum of FLASH is not correct
1101	11	I2C bus busy before start
1102		NVRAM access time-out
1103		No NVRAM Acknowledge
1104		NVRAM reply time-out
1201	12	I2C bus busy
1202		I2C bus not working
1203		Slave controller not responding
1204		Slave response is not correct
1301	13	Parity error from basic engine to serial
1302		Parity error from serial to basic engine
1303		No communication between serial and basic engine
1304		Communication time-out error
1601	16	The SDRAM is faulty
5201	52	I2C bus busy
5202		Error sending I2C command to COLOR SETUP IC
5203		Colour setup IC not responding
5204		Colour setup IC response is not correct
5401	54	I2C bus busy
5402		Error sending I2C command to SCART SWITCH IC
5403		SCART Switch is not responding
5403		SCART Switch response is not correct

CL06532096\_006.eps  
050700

Figure 5-37

Error log / bits table	Read ERROR LOG in player script	Read ERROR BITS in player script
Basic engine errors	Value:	Value:
Command to the Basic Engine not allowed in this state or unknown command	150101	8
Parameter(s) from the command to the Basic Engine is not valid	150102	7
Sledge could not be moved to the inner home position	150103	6
Focus failure	150104	5
Turntable motor speed could not be reached within timeout	150105	4
Radial servo could not get on track on the disc	150106	3
PLL could not lock in the accessing or tracking state	150107	2
Subcode or sector information could not be read	150108	1
requested subcode could not be found	150109	16
Tray could not be closed or opened completely	15010A	15
TOC could not be read within timeout	15010B	14
The requested seek on the disc could not be executed	15010C	13
A requested lead-in is not on the disc	15010D	12
A non existing burst cutting area is requested	15010E	11
S2b communication error	1501F0	10
S2b communication error	1501F1	9
S2b communication error	1501F3	24
S2b communication error	1501F4	23
S2b communication error	1501F5	22
Digital PWB errors		
Communication error with the Sti 5505	90000	32
Communication error with the Sti 5505	90001	31
Disply processor errors		
Communication error with the display processor	190000	40

### 5.6.1 Servicing DVD loader

The DVD Loader / mechanism, VAL6011, has to be exchanged completely in case of failure. A new mechanism can be ordered with codenumber 9305 023 61101.

### 5.6.2 Reprogramming of new mono boards.

#### Caution

**This information is confidential and may not be distributed. Only a qualified service person should reprogram the mono board.**

After reset of NV-memory or repair of the mono board, all the customer settings and also the region code will be lost.

Reprogramming of the mono board will put the player back in the state in which it has left the factory, i.e. with the default settings and the allowed region code.

Reprogramming is limited to 25 times

When the counter reaches 25, reprogramming is not possible anymore

Reprogramming will be done by way of the remote control.

Put the player in stop mode, no disc loaded.

Press the following keys on the remote control:

<PLAY> followed by numerical keys <1> <5> <9>

The display shows: “-----”

Press now successively the following keys :

for DVD703 /031: <0><1><3> <0><0><0><0><0><0><0><0><0>

for DVD703 /691: <0><1><0> <0><0><0><0><0><0><0><0><0>

for DVD703 /751: <0><1><2> <0><0><0><0><0><0><0><0><0>

for DVD703 /781: <0><2><1> <0><0><0><0><0><0><0><0><0>

Press <PLAY> again.

The TV screen will become BLUE during a short time to confirm that the mono board has been reprogrammed, then the set goes to standby mode.

CL 16532007\_050.eps  
050201

Figure 5-38

### 5.6.3 Reset of Virgin Mode

After the player has been powered up for test by the dealer, it would have gone through the Virgin Mode. It is possible to reset the settings made during that mode before the delivery of player to the customer. This can be done as shown in the following diagram:

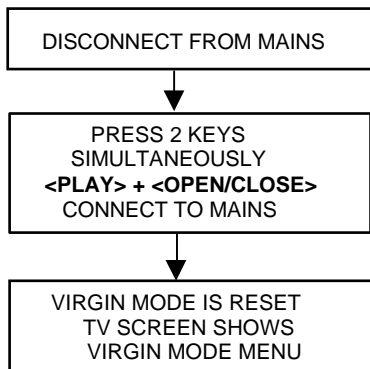

CL 96532065\_034.eps  
070700

Figure 5-39

#### TRADE MODE

*When the player is in Trade Mode, the player cannot be controlled by means of the front key buttons, but only by means of the remote control.*

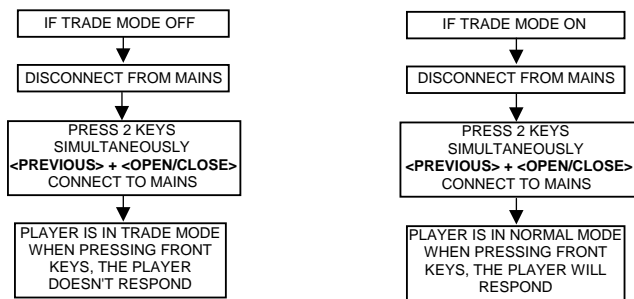

C06532096\_008.eps  
050700

Figure 5-40

## 5.7 Test Instruction Audio/Video Board

These test instructions can be used for all versions of the A/V board which has the following outputs:

- Audio L/R
- 5.1 Audio output
- Subwoofer output
- Optical / Coaxial digital output
- CVBS
- Y/G\_vid,U/B\_vid,V/R\_vid output
- S-video
- Scart output

### 5.7.1 General

- All the waveforms measurement carried out in these test instruction will be base on the testpoint indicated in the A/V board schematic diagram in the Service manual.
- Impedance of the measuring-equipment should be > 1M $\Omega$
- Most of the tests can be done using either the Diagnostic software "Player script" which can be found in the chapter "Diagnostic Software description and troubleshooting" or the Menu interface using the Service PC with a terminal emulation program ( e.g. Window Hyperterminal ) where it is possible to control the execution of the Diagnostic Nuclei
- Setup for the measurement will be done in set level with all modules connected as shown in the Wiring Block diagram.

### 5.7.2 General start-up measurement

#### Supply check:

Before starting the measurement,ensure that all power supply are connected to the A/V board.

Pin nbr	Supply
1010-9	-5V ( -Vcc )
1010-10	+5V
1010-11	+5V

The supply currents can be measured using a Tektronics AM503B current probe or equivalent.

Supply	Power consumption ( AVG )
+5VA	+5V $\pm$ 3% I = 200mA
+5Vvid	+5V $\pm$ 3% I = 200mA
-5V	-5V $\pm$ 3% I = 200mA

#### Clock Check

Ensure the present of the clock to the DAC

Clock Name	Testpoint	Frequency
PCM_CLK	TP10	11.2896MHz $\pm$ 0.02% tolerance

#### Audio mute check

Measure the Audio mute voltage input at pin 12 of connector 1010

Status	Value
AudioMuteOn	4.7V $\pm$ 10%
AudioMuteOff	-8V $\pm$ 10%

To toggle between ON and OFF,use the following commands:

Ref.#	Command Name	Remarks
19a	AudioMuteOn	Audio Mute On
19b	AudioMuteOff	Audio Mute Off

### 5.7.3 Audio DAC and amplifier

Ensure that the Audio mute signal is OFF

To check the DAC and buffer amplifier,send the following commands:

Ref.#	Command Name	Remarks	Audio output
21a	AudioSineOn	Audio Sine signal ON	Sine,1Khz on stereo
----	Press stop button	Audio Sine signal OFF	No waveform
20a	AudioPinkNoiseOn	Audio Pinknoise ON	Pink Noise on 6 channels
20b	AudioPinkNoiseOff	Audio Pinknoise OFF	No waveform

The audio signal ( sine or pink noise ) will also be present on the digital output ( SPDIF ).This can be checked by connecting digital signal to an amplifier with digital input. Check the I2S and audio signal at the following testpoints:

Name	Testpoint
LRCLK	TP8
SCLK	TP9
PCM_CLK	P10
PCM_OUT0	TP7
PCM_OUT1	TP27
PCM_OUT2	TP28
SPDIF	TP11
Front L/R out-Audio cinch	TP13
H/P L/R out	TP20
Analog out -Audio cinch	TP25

All waveforms can be refer to the waveform diagram in the chapter "Diagnostic software description and troubleshooting".

### 5.7.4 Video output and buffer amplifier

Check DC output-level at all video cinch output : 1.0V DC  $\pm$  10%

Generate a color bar using the following software commands:

Ref.#	Command Name	Remarks
23a	VideoColDencOn	Colour DENC ON
61a	VideoColOutRGB	RGB Colourbar
61b	VideoColOutYUV	YUV Colourbar
23b	VideoColDencOff	Colourbar DENC OFF

Check the video outputs at the following testpoints:

Name	Testpoint
B_VID	TP1
G_VID	TP2
R_VID	TP3
CVBS out	TP14
S-Video-C out	TP15
S-Video-Y out	TP16
Y out	TP17
U out	TP18
V out	TP19

All waveforms can be refer to the waveform diagram in the chapter "Diagnostic Software description and troubleshooting".

5.7.5 Play and 16/9 detection

Check DC voltage at S-Video-chroma output (pin 4) with a 6K8 ohm load and Scart connector (pin 8) and change the 0/6/12 input (1010-8) using the following commands:

Ref.#	Command Name	Remarks	Chroma output
25a	VideoScartLo	Sends out 0V ± 0.5V	<0.1V
25b	VideoScartMi	Sends out 6V ± 10%	2.0V ± 10% with load 5.0V ± 10% without load
25c	VideoScartHi	Sends out 12V ± 10%	<0.1V

5.7.6 Kill circuit

To check the functionality of the Kill circuitry, the audio outputs has to be present by the following command:

Ref.#	Command Name	Remarks	Audio output
21a	AudioPinkNoiseOn	Audio Pinknoise ON	Pink Noise on 6 channels

Check the audio outputs at the audio cinch of the A/V board : Pink Noise

Activate the Kill circuit by using the following command:

Ref.#	Command Name	Remarks
19a	AudioMuteOn	Audio Mute On

Check the audio outputs at the audio cinch of the A/V board : No waveform

Switch off the kill circuit by using the following command:

Ref.#	Command Name	Remarks
19b	AudioMuteOff	Audio Mute Off

Check the audio outputs at the audio cinch of the A/V board : Pink Noise

5.8.2 Functionality description:

The essential component of the display PCB is the μP (slave). This slave works on an 8MHz resonator and has a reset circuit that is triggered by the +5Vstby. After the reset pulse, the standby control line will release the reset of the host μP. This host μP will then initialise the slave. In addition, when going to stand-by, the slave will put the host μP in reset. When the slave receives the right IR or key code to leave the standby mode, the reset of the host μP will be released.

Other slave functions are:

- Square signal generator to generate the filament voltage, which is required for an AC FTD.
- Generates the grid and segment scanning for the FTD.
- Generates a scanning grid for the keys (separated from display scanning).
- Has inputs for RC (RC5 and RC6) and P50 (P50 controller is built in).

5.8.3 General

- Oscilloscope measurements have been carried out using a Philips PM3392A.
- Impedance of measuring-equipment should be > 1MΩ.
- To do correct measurements we recommend to use supply 3122 427 22600.

5.8 Test instructions Display board

5.8.1 Introduction

These test instructions are written for all versions of the display PCBAS.

The contents of the PCB can be split up into next blocks:

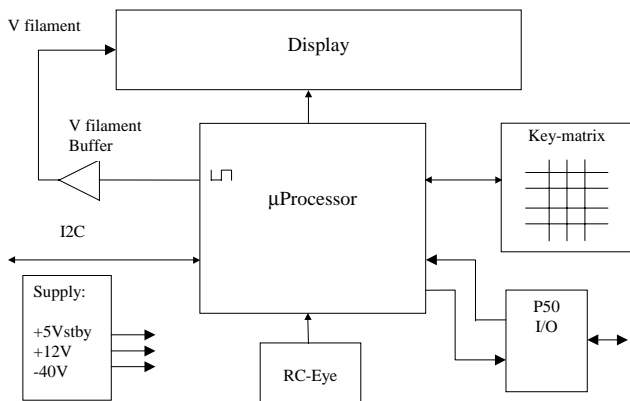

CL 96032065\_058.eps  
130799

Figure 5-41

**5.8.4 Reset**

Check next reset timing with an oscilloscope at pin 10 of the microprocessor.

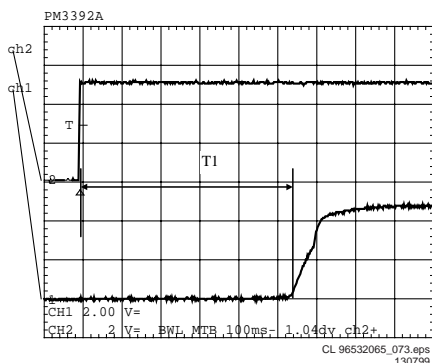
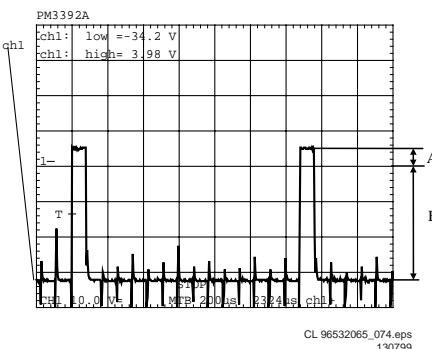

**Figure 5-42**

Timing: 400msec < T1 > 700msec.  
 CH1: +5Vstby voltage at power on.  
 CH2: Voltage at pin 10.

**5.8.5 Display steering**

Check next timing and level for all grid-lines (G1 r G14).



**Figure 5-43**

1. Check level A: +4V5 +/-10% for grid lines 1 => 11
2. Check level A: +4V0 +/-10% for grid lines 12 => 14
3. Check level B: -33V +/-10%
4. Check timing and levels of segment-lines P1 => P10:

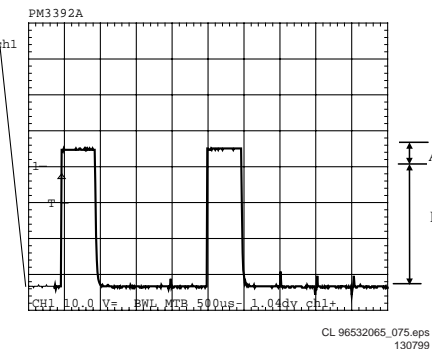

**Figure 5-44**

Level A: +4V5 +/-10%  
 Level B: -33V +/-10%  
 The data on these segment lines depend on the characters that are displayed.  
 The characters can be set by sending I2C commands to the display.

See the Slave URS how to send a display command.

**5.8.6 Key-matrix**

Connect a extra 10kΩ pull-up to pin 36 en 37 of the μP and check next matrix scanning at these pins.

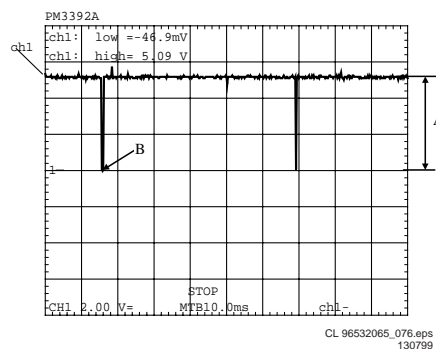

**Figure 5-45**

Level A: 5.0V +/-7%  
 Level B: 0V +/-200mV  
 Check matrix scanning from pin 26 until 33 of the μP.  
 The results should be the same as the diagram above.

**5.8.7 I.R. receiver**

Check at pin 23 of the μP if this line switches from low (< 0.3V) to high (> 4.5V), while pressing a key on a Philips RC5 or RC6 remote control.

**5.8.8 Karaoke interface**

The karaoke interface (4 lines) is a single direction communication. This means that it consists of four μP output lines. The interface can be checked by setting or resetting these output-ports via the I2C bus.

- Send next command via the I2C bus:
- |              |                       |
|--------------|-----------------------|
| Address      | : 0x70                |
| Command byte | : 0x24                |
| Data byte    | : xxxxabcd            |
| Where        | : a = Karaoke reset.  |
|              | : b = Karaoke data.   |
|              | : c = Karaoke clock.  |
|              | : d = Karaoke strobe. |

**5.8.9 P50 interface**

P50 is a bi-directional serial interface, which is used for communication between video equipment. For European sets, this communication goes via pin 10 of the scart-bus. In other regions, it can be a cinch bus at the back of the set.

1. Keep the μP in reset by short-circuiting emitter and collector of transistor 7108, via resistor 3100 and 3104 transistor 7101 is switched on.
2. Check the voltage at the P50 output connector 1118-5: < 200mV.

When the reset is released the μP output-pin becomes low and transistor 7101 is switched off.

1. Check the voltage at the P50 output connector 1118-5: 4V9 +/-5%.
2. Check also the μP P50 input (μP pin 20): 5V +/-5%.
3. Connect the P50 line (connector 1118-5) to ground.
4. Check again the μP P50 input (μP pin 20): <0V3.

5.9 Troubleshooting

5.9.1 Troubleshooting A/V board

Testing of A/V board can be done using diagnostic software "PLAYER SCRIPT".

MONO board is used to generate a sound with the sound tests SND-1 and SND-2 or a VIDEO signal with the picture "DIAGNOSTIC SOFTWARE: SCRIPT INTERFACES".

**AUDIO PART OF AUDIO/VIDEO BOARD 3139 243 30161**

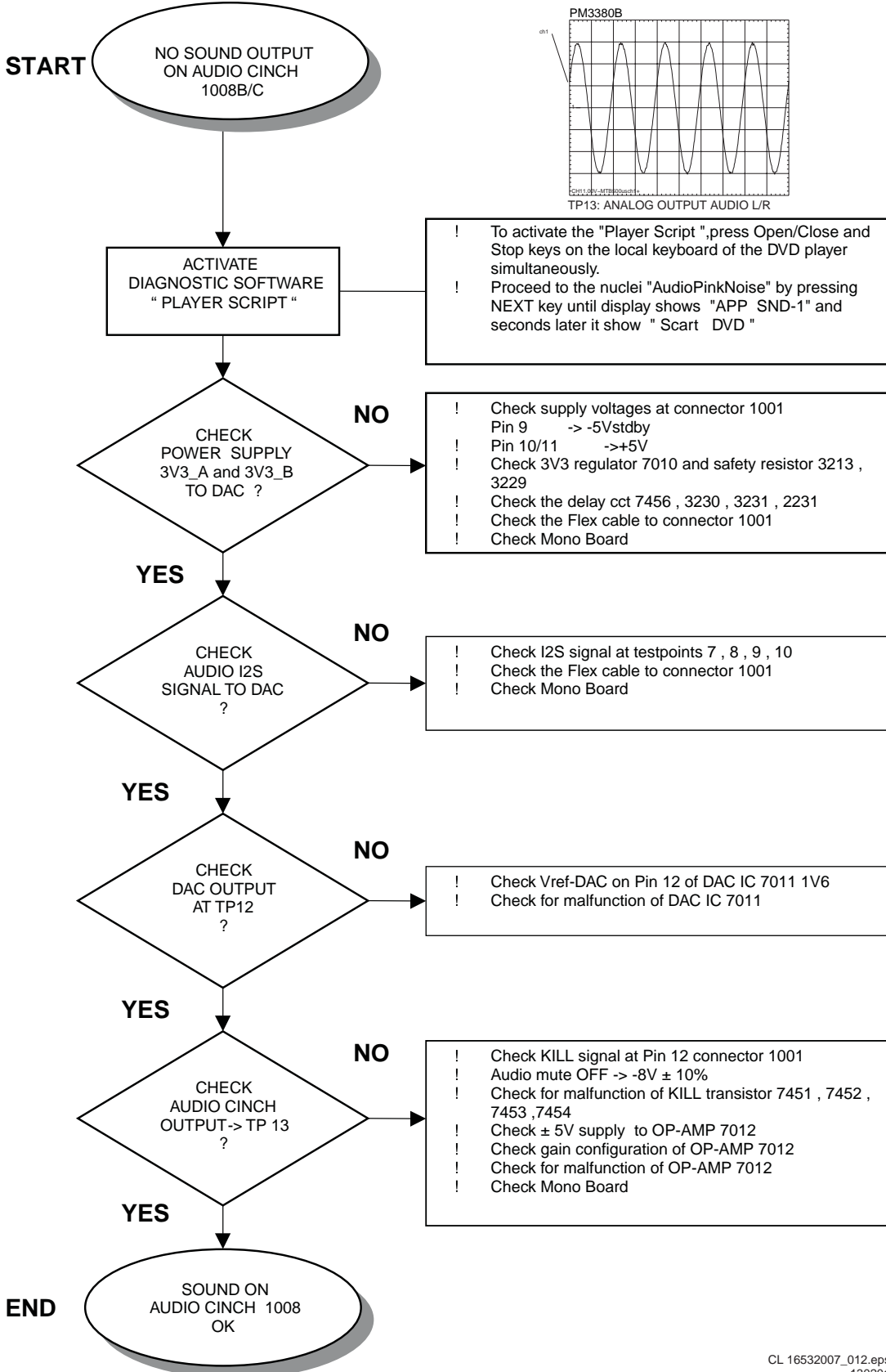



AUDIO WAVEFORM MEASUREMENT

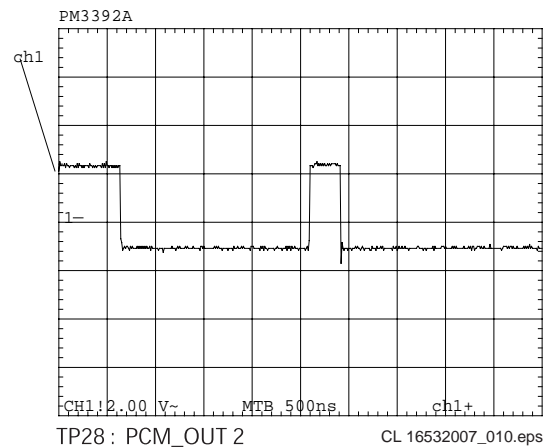
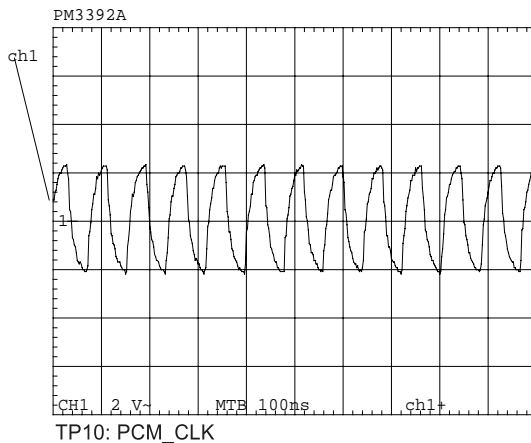
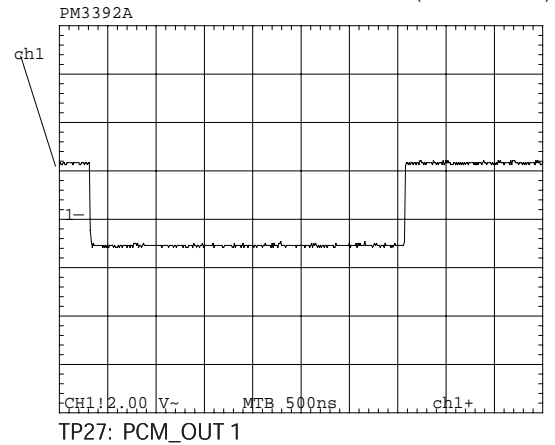
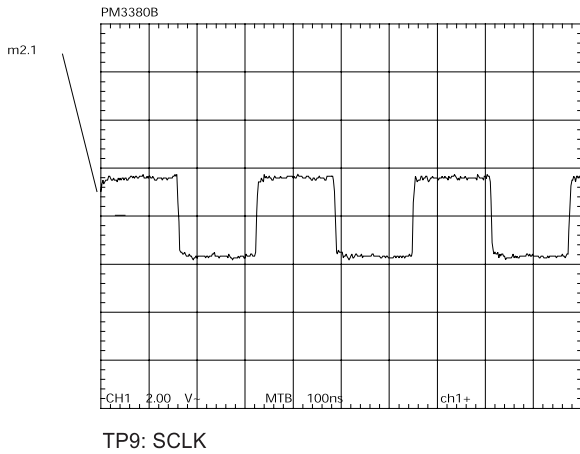
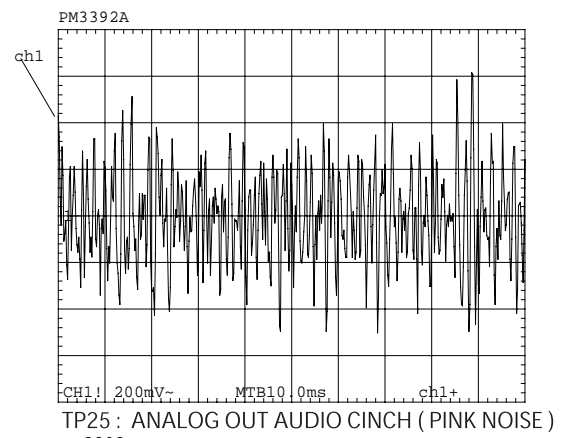
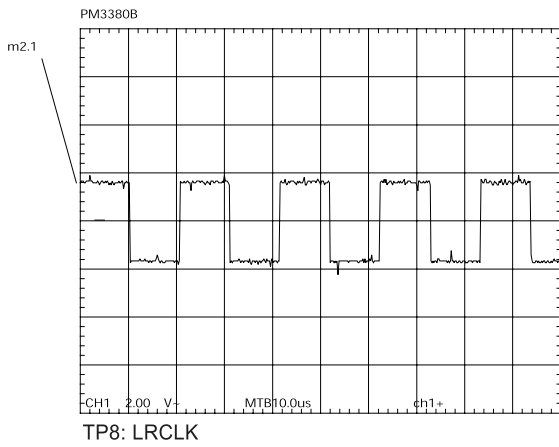
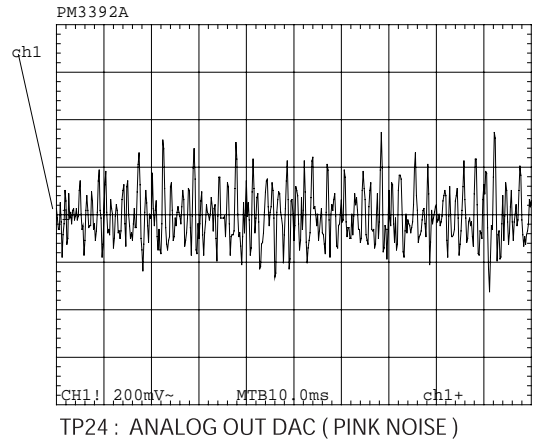
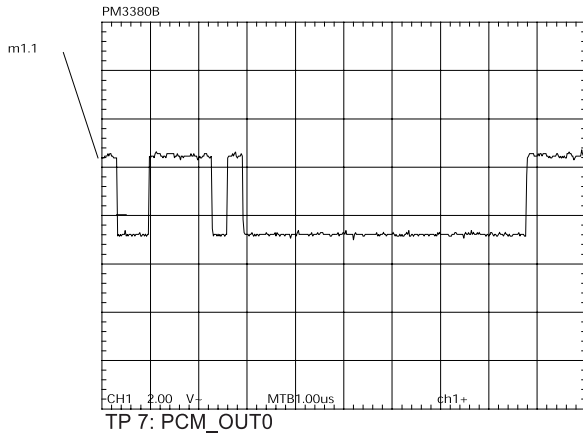

# AUDIO PART OF AUDIO/VIDEO BOARD 3139 243 30161

**START**

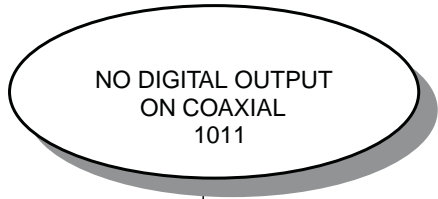

ACTIVATE DIAGNOSTIC SOFTWARE "PLAYER SCRIPT"

! To activate the "Player Script ",press Open/Close and Stop keys on the local keyboard of the DVD player simultaneously.  
 ! Proceed to the nuclei "AudioPinkNoise" by pressing NEXT key until display shows "APP SND-1" and seconds later it show " Scart DVD ".

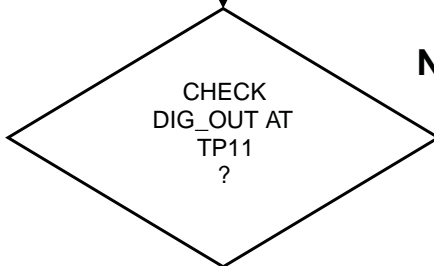

**NO**

! Check Flex cable to connector 1001.  
 ! Check Mono Board.

**YES**

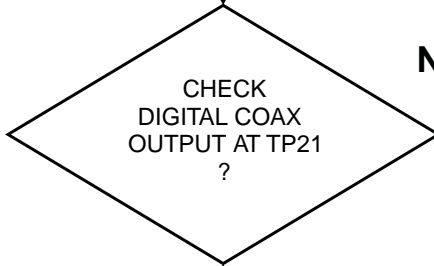

**NO**

! Check coupling transformer 5008.  
 ! Check coupling components 3225, 3226, 2225.

**END**

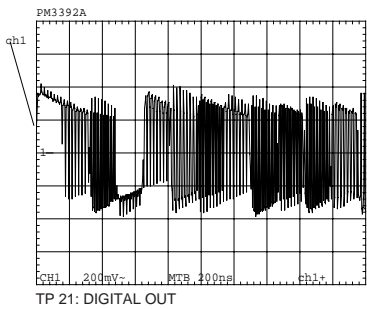
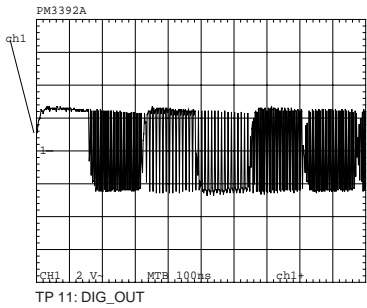
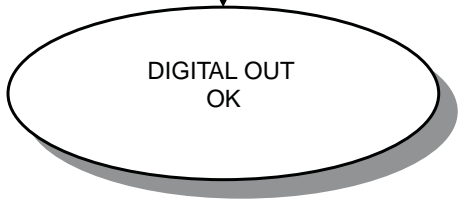

**VIDEO PART OF AUDIO/VIDEO BOARD 3139 243 30161**

**START**

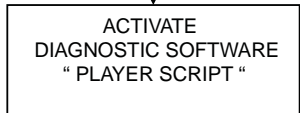
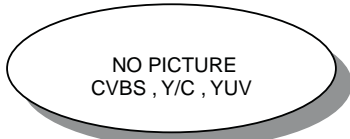

! To activate the "Player Script ",press Open/Close and Stop keys on the local keyboard of the DVD player simultaneously.  
! Proceed to the nuclei "VideoColDencOn" by pressing NEXT key until display shows "APP PIC-1"

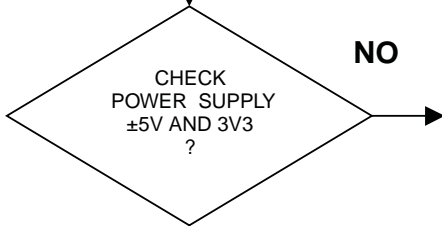

**NO**  
! Check supply voltages at connector 1001  
! Pin 9 -> -5Vstdby  
! Pin 10/11 -> +5V  
! Check 3V3 regulator 7010 and safety resistor 3213 , 3229  
! Check the delay cct 7456 , 3230 , 3231 , 2231  
! Check the Flex cable to connector 1001  
! Check Mono Board

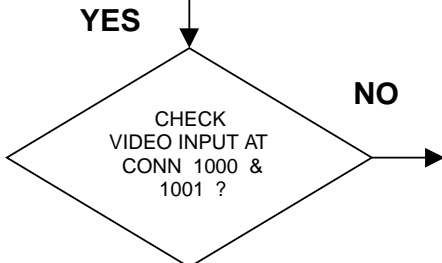

**NO**  
! Check video signal at TP1 B\_Vid , TP2 G\_Vid  
! TP3 R\_Vid , TP4 CVBS , TP5 C , TP6 Y  
! Check the Flex cable to connector 1001 & 1000  
! Check Mono Board

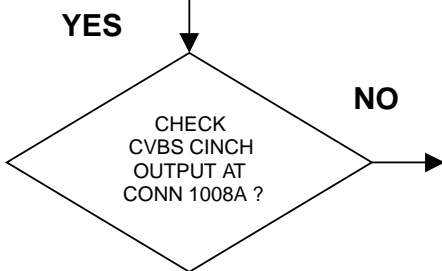

**NO**  
! Check CVBS signal at testpoint 14  
! Check for ± 5V supply to Video buffer amplifier  
! Check for malfunction of Video buffer amplifier 7411, 7412 , 7413 , 7414 and the biasing configuration

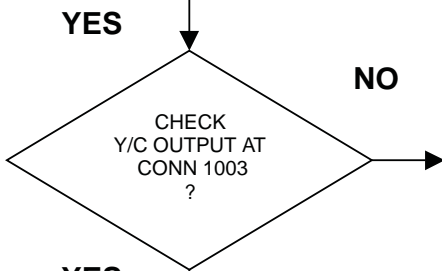

**NO**  
! Check Y/C signal at TP 16 and TP15 respectively  
! Check for ± 5V supply to Video buffer amplifier  
! Check for malfunction of Video buffer amplifier 7407, 7408,  
! 7410, 7457, 7458, 7455 and the biasing configuration

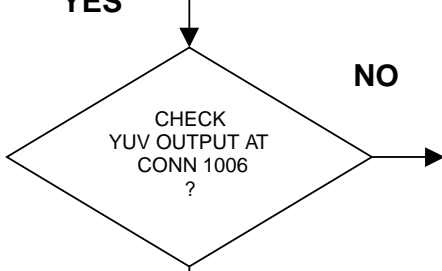

**NO**  
! Check YUV signal at TP 17, TP18 and TP19 respectively  
! Check for ± 5V supply to OPAMPS 7001 and transistor buffer 7415  
! Check for malfunction of OPAMPS 7001 and transistor buffer 7415

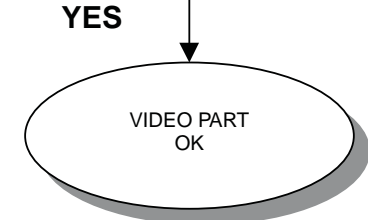

**END**

VIDEO WAVEFORM MEASUREMENT

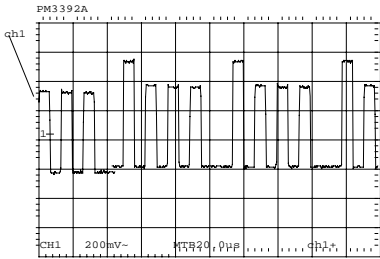

TP 1 : VIDEO B

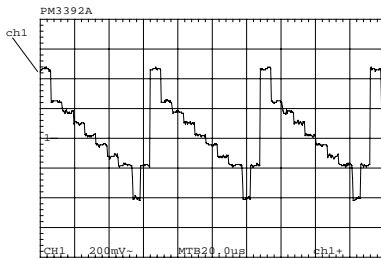

TP 6 : Y\_ENC

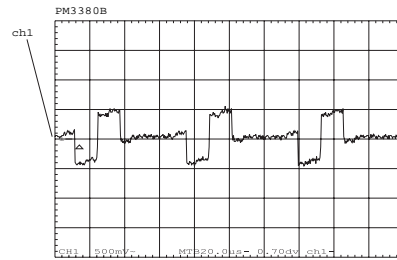

TP 19 : V\_VID OUT

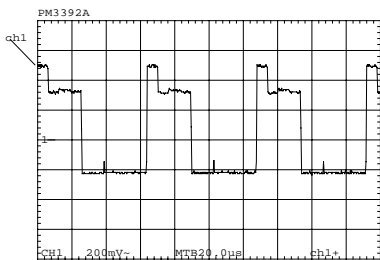

TP 2 : VIDEO G

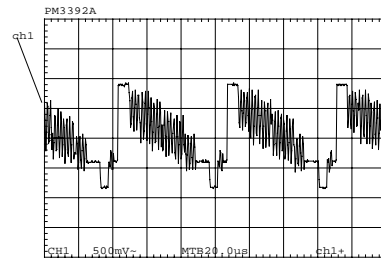

TP 14 : CVBS\_OUT

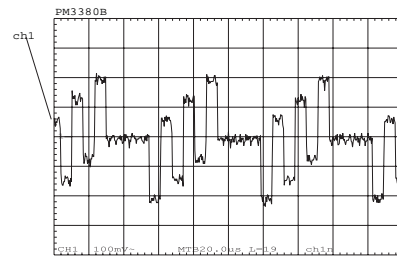

TP 22 : U\_VID

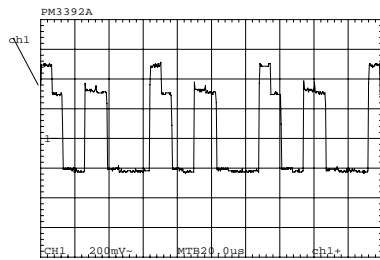

TP 3 : VIDEO R

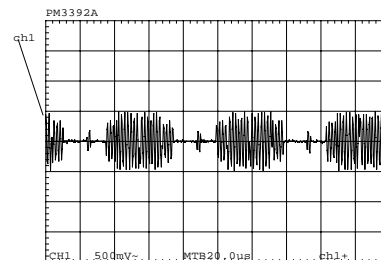

TP 15 : C\_OUT

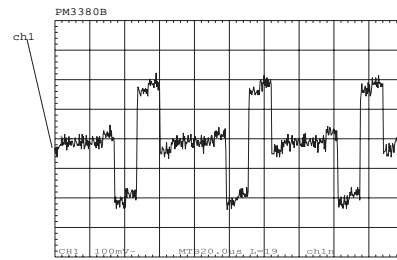

TP 23 : V\_VID

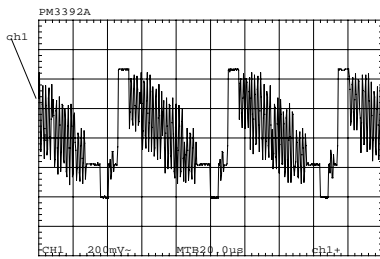

TP 4 : CVBS

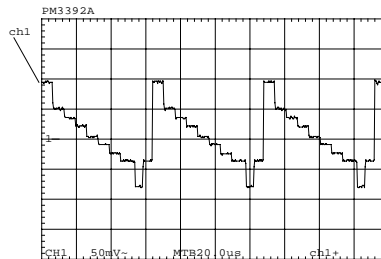

TP 16 /17 : Y\_OUT

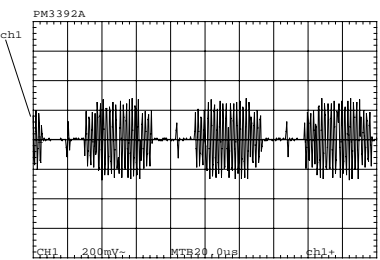

TP 5 : C\_ENC

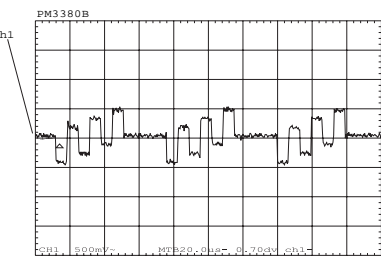

TP 18 : U\_VID OUT

## TROUBLESHOOTING POWER SUPPLY UNIT VFM WR

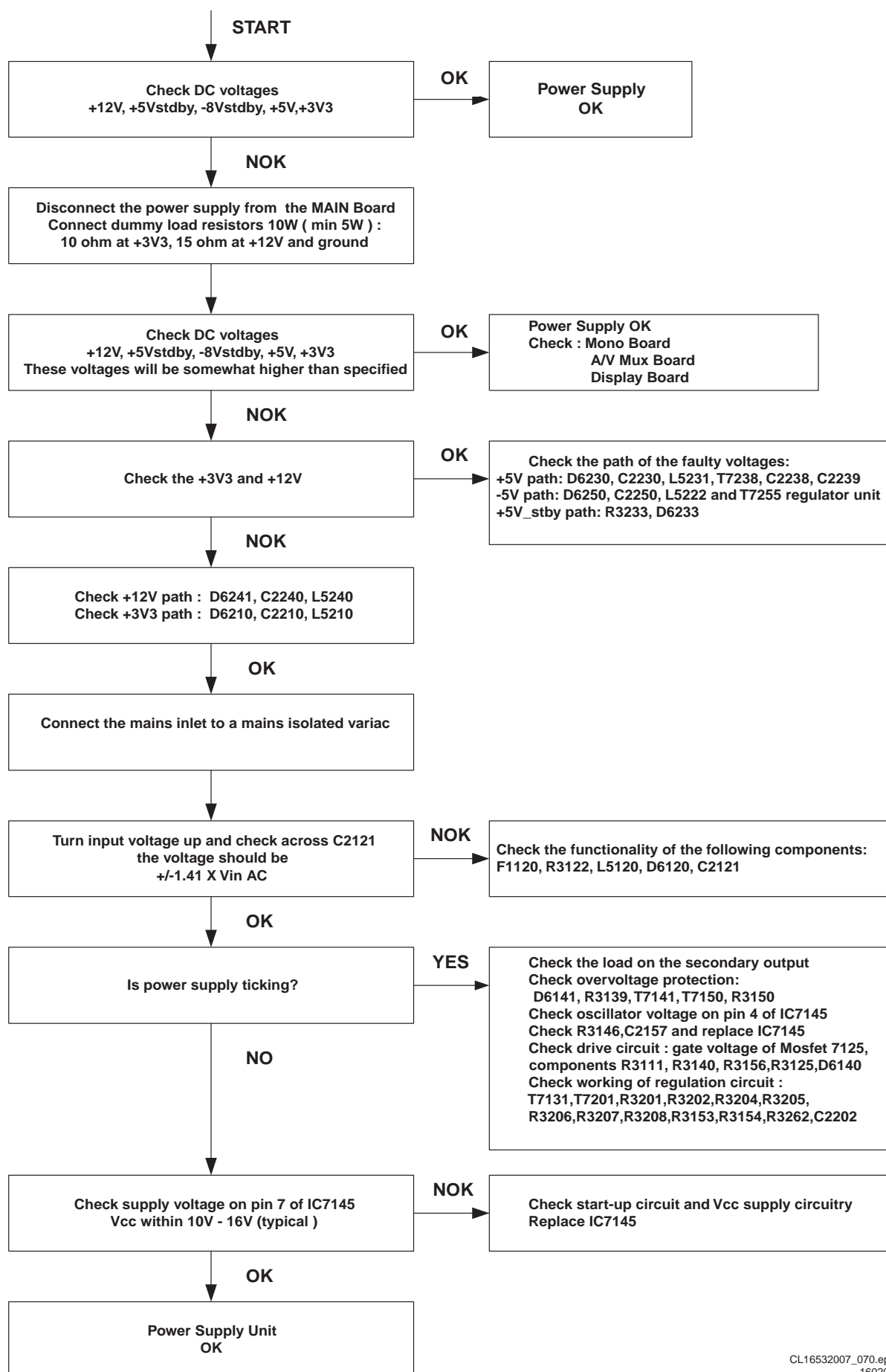



## 8. Alignments

No electrical alignments available

## 9. Circuit descriptions and list of abbreviations

### 9.1 Current mode Power Supply

#### 9.1.1 Introduction

The switch mode power supply ( SMPS ) is mains isolated. The control IC 7145 ( UC 3842A ) produces pulses to drive the power switch, Mosfet 7125.

Power supply regulation is achieved by using duty cycle control at fix frequency ,of approximately 58KHz ,determined by the RC timing components.

#### 9.1.2 General Description of UC 3842A

The UC 3842 is a high performance fixed frequency current mode controller that is specifically designed for off-line and DC-to-DC converter application. This integrated circuit feature a trimmed oscillator for precise duty cycle control, a temperature compensated reference, high gain error amplifier, current sensing comparator and a high current totem pole output ideally suited for driving a power MOSFET. Also included are protective features consisting of input and reference undervoltage lockouts each with hysteresis, cycle by cycle current limiting, programmable output deadtime and a latch for single pulse metering.

A representative Block diagram and Pin function description is shown in Fig 1 and Fig 2 respectively.

#### 9.1.3 BLOCK DIAGRAM

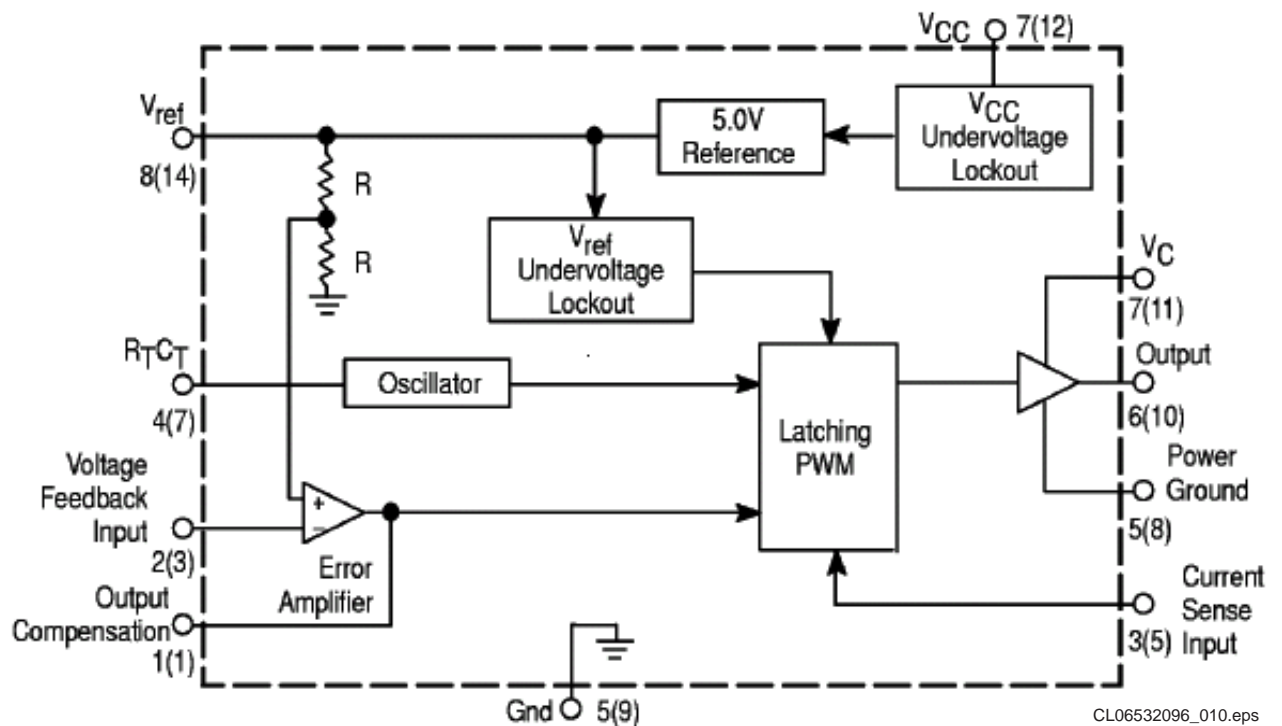

CL06532096\_010.eps  
060700

Figure 9-1

### 9.1.4 Pin function description

Pin		Function	Description
8-Pin	14-Pin		
1	1	Compensation	This pin is Error Amplifier output and is made available for loop compensation.
2	3	Voltage Feedback	This is the inverting input of the Error Amplifier. It is normally connected to the switching power supply output through a resistor divider.
3	5	Current Sense	A voltage proportional to inductor current is connected to this input. The PWM uses this information to terminate the output switch conduction.
4	7	$R_T/C_T$	The Oscillator frequency and maximum Output duty cycle are programmed by connecting resistor $R_T$ to $V_{ref}$ and capacitor $C_T$ to ground. Operation to 500 kHz is possible.
5	–	Gnd	This pin is the combined control circuitry and power ground (8-pin package only).
6	10	Output	This output directly drives the gate of a power MOSFET. Peak currents up to 1.0 A are sourced and sunk by this pin.
7	12	$V_{CC}$	This pin is the positive supply of the control IC.
8	14	$V_{ref}$	This is the reference output. It provides charging current for capacitor $C_T$ through resistor $R_T$ .
–	8	Power Ground	This pin is a separate power ground return (14-pin package only) that is connected back to the power source. It is used to reduce the effects of switching transient noise on the control circuitry.
–	11	$V_C$	The Output high state ( $V_{OH}$ ) is set by the voltage applied to this pin (14-pin package only). With a separate power source connection, it can reduce the effects of switching transient noise on the control circuitry.
–	9	Gnd	This pin is the control circuitry ground return (14-pin package only) and is connected back to the power source ground.
–	2,4,6,13	NC	No connection (14-pin package only). These pins are not internally connected.

CL06532096\_011.eps  
060700

Figure 9-2

### 9.1.5 Pin connection

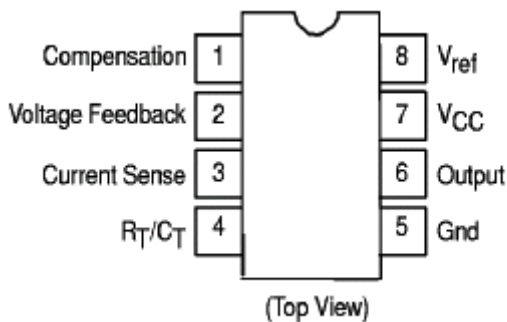

CL06532096\_012.eps  
060700

Figure 9-3

### 9.1.6 Output voltages

- +12V ( For Display board, Monoboard, A/V board ) created via D6241, C2240, L5240, C2232 (This voltage is also present during standby)
- +5V\_ stdby ( For Display board, Standby PCB, Monoboard ) created from +6V via R3233 and D6233 (This voltage is also present during standby)
- +6V\_ stdby ( Reserve ) created from D6230, C2230, L5231 (This voltage is also present during standby)
- +5V ( For Monoboard, A/V board ) derive from +6V stdby via Mosfet 7238, C2239 and it will be switch off via R3235, T7235 during Standby.
- 5V ( For Monoboard, A/V board ) created from D6250, C2250, C2259, L5222, R3259, T7255 regulator circuit and will switch off via R3258, T7257 during standby (control signal Standby is HIGH)

- 3V3 ( For Monoboard, A/V board ) The 3V3 power supply is regulated by the control loop comprising of 7201, 7131 and 7145 of the switch mode PSU. This voltage is also present during standby
- 40V ( For Display board ) created via D6261, R3260, L5260, C2260 This will not be present during standby

## 9.2 CONTROL CIRCUITRY

### 9.2.1 Mains input circuit

The mains voltage is rectified by bridge rectifier (D6118 to D6121) and filter by C2121. The DC voltage across C2121 is the DC input voltage ,approximately 300V, is the DC input to pin 1 of transformer T5131. The mains input also consists of a lighting protection R3120.

### 9.2.2 Start-up and takeover circuitry

The start-up circuitry consist R3123, R3134, R3111, D6129, C2134 and with the mains voltage input, the C2134 will charge via R3123 and R3134. When the voltage at pin 7 of IC7145 reaches the start-up threshold of min 14.5V, IC7145 will start-up and the control circuit start to operate. After start-up, the max sinking current of 17mA is required by IC7145 which is not able to be delivered by the start-up circuitry, so the takeover circuitry must be present. If the takeover circuit does not occurred, the supply voltage at pin 7 will decrease gradually till it reaches the IC7145 minimal operating voltage of 8.5V and the IC will switch off. The whole operation cycle will repeat itself with audible hiccup sound if takeover is not present.

The takeover circuit comprises of D6133, R3135, I5135, C2134. During the control circuit start-up, the voltage across winding pin 7 and 9 will gradually built up and charged C2134



via D6133, R3135 which will takeover the supply voltage of T7145 at pin 7.

it goes into the overvoltage protection and a complete restart sequence is required.

### 9.2.3 Secondary voltage sensing

The secondary voltage regulating circuit comprise of the opto-coupler 7131 which isolate the error signal from the control IC7145 ,on the primary side, and a reference component 7201 ( TL431 ). The 7201 can be represented by two components:

- A very stable and accurate reference diode
- A high gain amplifier

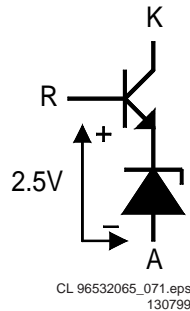

Figure 9-4

When the output voltage increases, due to a reduction in the load, the voltage across R3205 and R3206 increases to above the internal reference voltage of about 2.5V then TL431 conduct. The current through the opto-coupler 7131 will increase due to the fact that the series resistor in 7201 decreases. This result in a increase of voltage to pin 2 of IC7145, thus reducing the on-time of FET 7125. In the event of a decrease in output voltage (increase in load ),the control circuit will operate in the opposite way to the explanation above.

### 9.2.4 Primary current sensing

The current through the FET 7125 resulting in a voltage drop across R3126,R3127,R3128 which is couple to pin 3 of IC7145,current sense input.The higher the input voltage, the more the primary current is limited. In this way the maximum output power of the power supply is limited.

### 9.2.5 Undervoltage protection

Two undervoltage lockout comparators have been incorporated to guarantee that the IC7145 is fully functional before the output stage is enable. The supply voltage at pin 7 and reference voltage at pin 8 of IC7145 are each monitored by separate comparators with built-in hysteresis. If the supply voltage at pin 7 of IC7145 drops below 10V ( typical ), due to a secondary voltage is short-circuit or excessive load, the drive pulse at pin 6 of IC7145 will be disabled and the controller will switch off the complete SMPS.

Remarks : In the event of the overvoltage situation remaining present, the SMPS will go in sequence of protection,start- up cycle, protection and the cycle repeats. This effect is highly audible.

### 9.2.6 Overvoltage protection

The overvoltage circuitry comprising of D6141,R3139, R3150, R3141,T7141, T7150 which is used to detect an over voltage situation on the secondary side of the transformer. After start-up, when the voltage across C2135 exceeds 18V,the overvoltage circuit will trigger the internal latch circuit, pin 1 of IC7145 and the output buffer is disabled and

### 9.3 List of abbreviations

B	Buffered Video input Blue from DVD monoboard
BC_AUX	Blue or Chroma input from AUX-scart
BC_TV	Blue or Chroma output to TV-scart
C_ENC	Buffered Chroma input from DVD monoboard
CVBS	Buffered Composite video input from DVD monoboard
DC_OFF	Control signal to switch off $\hat{u}8V_{stby}$ and $+12V_{stby}$ during standby
DIG_OUT	Digital out
FBIN_AUX	Fast blanking input from AUX-scart
FBOUT_TV	Fast blanking output to TV-scart
G	Buffered Video input Green from DVD monoboard
GIN_AUX	Video input Green from AUX-scart
GOUT_TV	Video output Green to TV-scart
HP_L	Audio output left to headphone and audio scart switch TEA6420
HP_R	Audio output right to headphone and audio scart switch TEA6420
KILL	Kill control signal for audio outputs and for soft mute of DAC
LIN_AUX	Audio input left from AUX-scart
LIN_TV	Audio input left from TV-scart
LOUT_AUX	Audio output left to AUX-scart
LOUT_TV	Audio output left to TV-scart
LRCLK	Left/Right clock
PCM_CLK	Audio system clock for DAC
PCM_OUT0	Audio serial output data
R	Buffered Video input Red from DVD monoboard
RCIN_TV	Red or Chroma input from TV-scart
RCOUT_TV	Red or Chroma output to TV-scart
RIN_AUX	Audio input right from AUX-scart
RIN_TV	Audio input right from TV-scart
ROUT_AUX	Audio output right to AUX-scart
ROUT_TV	Audio output right to TV-scart
SCL	I2C bus clock
SCLK	Audio serial bit clock
SDA	I2C bus data
SELECT	Control signal for video scart switches; high = TV ,low = AUX
SELECT_HIGH	Control signal for switching fast blanking and slow blanking signals; high = TV ,low = AUX
SLB_AUX	Slow blanking control signal from AUX-scart
SLB_TV	Slow blanking control signal to TV-scart
STANDBY	Control signal from ST15505 used to switch off $\hat{u}8V_{stby}$ and $+12V_{stby}$ during standby.
STEREO_L	Audio cinch output left
STEREO_R	Audio cinch output right
Y_ENC	Buffered Luma input from DVD monoboard
YCVBSIN_AUX	Luma or CVBS input from AUX-scart
YCVBSIN_TV	Luma or CVBS input from TV-scart
YCVBSOUT_AUX	Luma or CVBS output to AUX-scart
YCVBSOUT_TV	Luma or CVBS output to TV-scart
0/6/12	Scart switch control signal A/V board. 0V : loop through (AUX to TV), 6V : play 16:9 format, 12V : play 4:3 format









0060	3139 241 20110	DOOR SPRING	0244	3139 247 50760	FOOT ASSY DVD751
0200	3139 247 53391	FRONT ASSY DVD703/ 69X	0245	3139 247 50760	FOOT ASSY DVD751
0205	3139 247 53161	BTN POWER DVD733K/ 69X PPT	0265	4822 321 11139	POWER CORD
0224	3139 247 53231	BACK PLATE DVD703/17X PPT	0381	2422 076 00304	CABLE CINCH/CINCH 1M5 YE/RD/WH
0232	3139 247 51170	COVER TOP DVD751/ OOX PNT PRT	0384	3139 228 87041	PROD.ASSY RC19137001/ 01 PACKED
0244	3139 247 50760	FOOT ASSY DVD751	0387	3139 246 10991	IFU DVD703/78X
0245	3139 247 50760	FOOT ASSY DVD751	1002	3139 248 81191	PCBAS AV DVD 703 AP SD1
0265	4822 321 11139	POWER CORD	1003	3139 248 80951	PCBAS FR DVD712 AP
0381	2422 076 00304	CABLE CINCH/CINCH 1M5 YE/RD/WH	1005	3122 427 22600	PSU DVD VFM WR
0384	3139 228 87041	PROD.ASSY RC19137001/ 01 PACKED	1014	4822 320 12674	CWAS FFC BD 22P 14P
0387	3139 246 10961	IFU DVD703/69X	1018	3139 110 34230	FFC FOIL 16P/105/16P BD B
1002	3139 248 81191	PCBAS AV DVD 703 AP SD1			
1003	3139 248 80951	PCBAS FR DVD712 AP			
1005	3122 427 22600	PSU DVD VFM WR			
1014	4822 320 12674	CWAS FFC BD 22P 14P			
1018	3139 110 34230	FFC FOIL 16P/105/16P BD B			

**DVD703/751****Various**

0010	3139 247 53451	CAB FRONT DVD703/69X PPT
0015	4822 459 10887	
0030	3139 247 53141	WINDOW DVD733K/69X PPT
0035	3139 247 53501	RING DVD703/69X PPT
0040	3139 247 50880	BTN CONTROL DVD751/ OOX PNT PRT
0045	3139 240 00030	DVD LOGO DVD711
0050	3139 247 50940	DOOR DVD751/00X PNT PRT
0060	3139 241 20110	DOOR SPRING
0200	3139 247 53391	FRONT ASSY DVD703/ 69X
0205	3139 247 53161	BTN POWER DVD733K/ 69X PPT
0224	3139 247 53231	BACK PLATE DVD703/17X PPT
0232	3139 247 51170	COVER TOP DVD751/ OOX PNT PRT
0244	3139 247 50760	FOOT ASSY DVD751
0245	3139 247 50760	FOOT ASSY DVD751
0265▲	3139 128 75230	MAINSCORD AUS/NZ 10A 2M6 VH BK
0381	2422 076 00304	CABLE CINCH/CINCH 1M5 YE/RD/WH
0384	3139 228 87041	PROD.ASSY RC19137001/ 01 PACKED
0387	3139 246 10971	IFU DVD703/75X
1002	3139 248 81191	PCBAS AV DVD 703 AP SD1
1003	3139 248 80951	PCBAS FR DVD712 AP
1005	3122 427 22600	PSU DVD VFM WR
1014	4822 320 12674	CWAS FFC BD 22P 14P
1018	3139 110 34230	FFC FOIL 16P/105/16P BD B

**DVD703/781****Various**

0010	3139 247 53451	CAB FRONT DVD703/69X PPT
0015	4822 459 10887	
0030	3139 247 53141	WINDOW DVD733K/69X PPT
0035	3139 247 53501	RING DVD703/69X PPT
0040	3139 247 50880	BTN CONTROL DVD751/ OOX PNT PRT
0045	3139 240 00030	DVD LOGO DVD711
0050	3139 247 50940	DOOR DVD751/00X PNT PRT
0060	3139 241 20110	DOOR SPRING
0200	3139 247 53391	FRONT ASSY DVD703/ 69X
0205	3139 247 53161	BTN POWER DVD733K/ 69X PPT
0224	3139 247 53231	BACK PLATE DVD703/17X PPT
0232	3139 247 51170	COVER TOP DVD751/ OOX PNT PRT

### 6. Block- and wiringdiagram.

#### Blockdiagram DVD 703 /XX1

#### Block Diagram DVD703/XX1

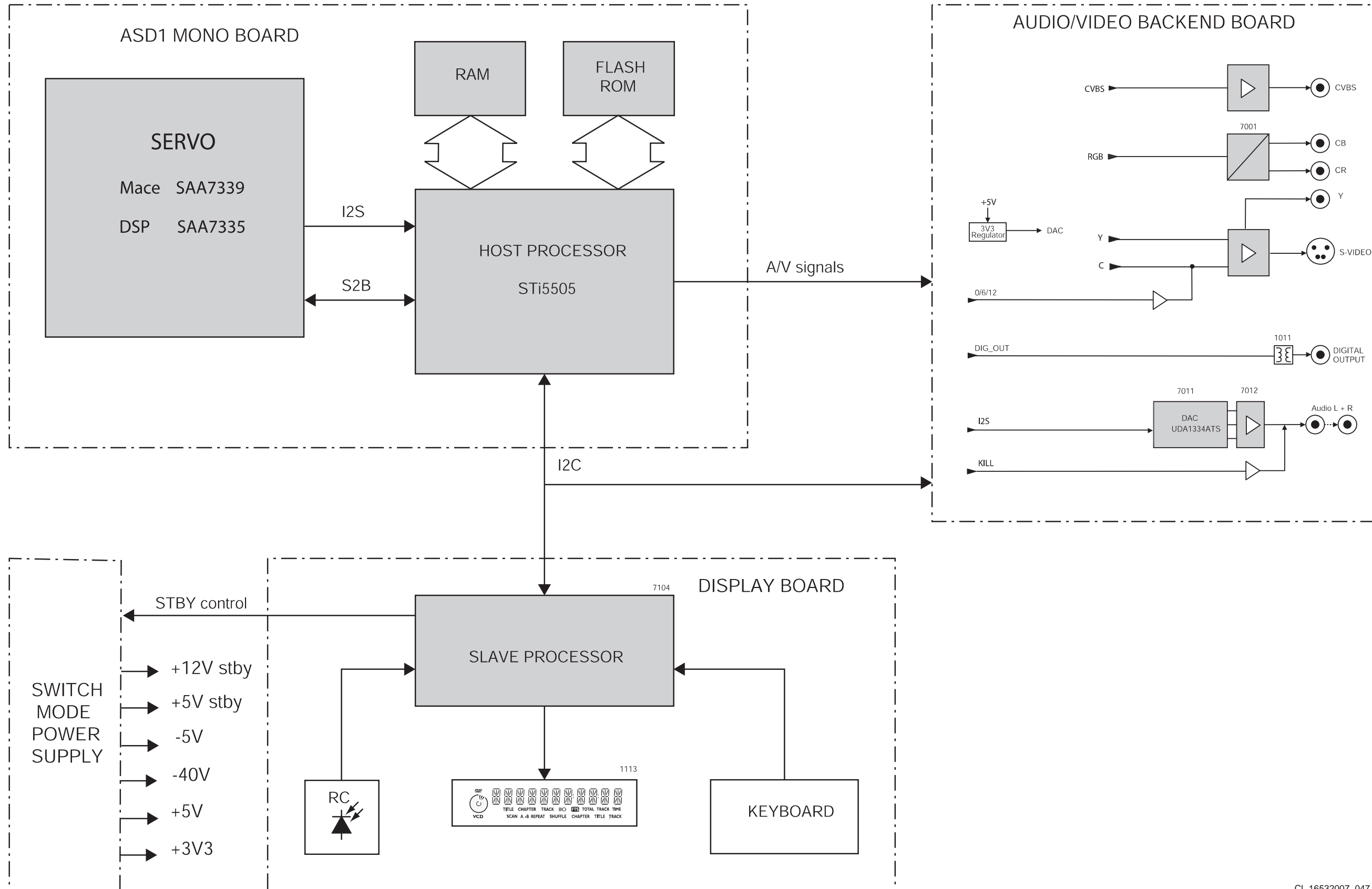



Wiringdiagram

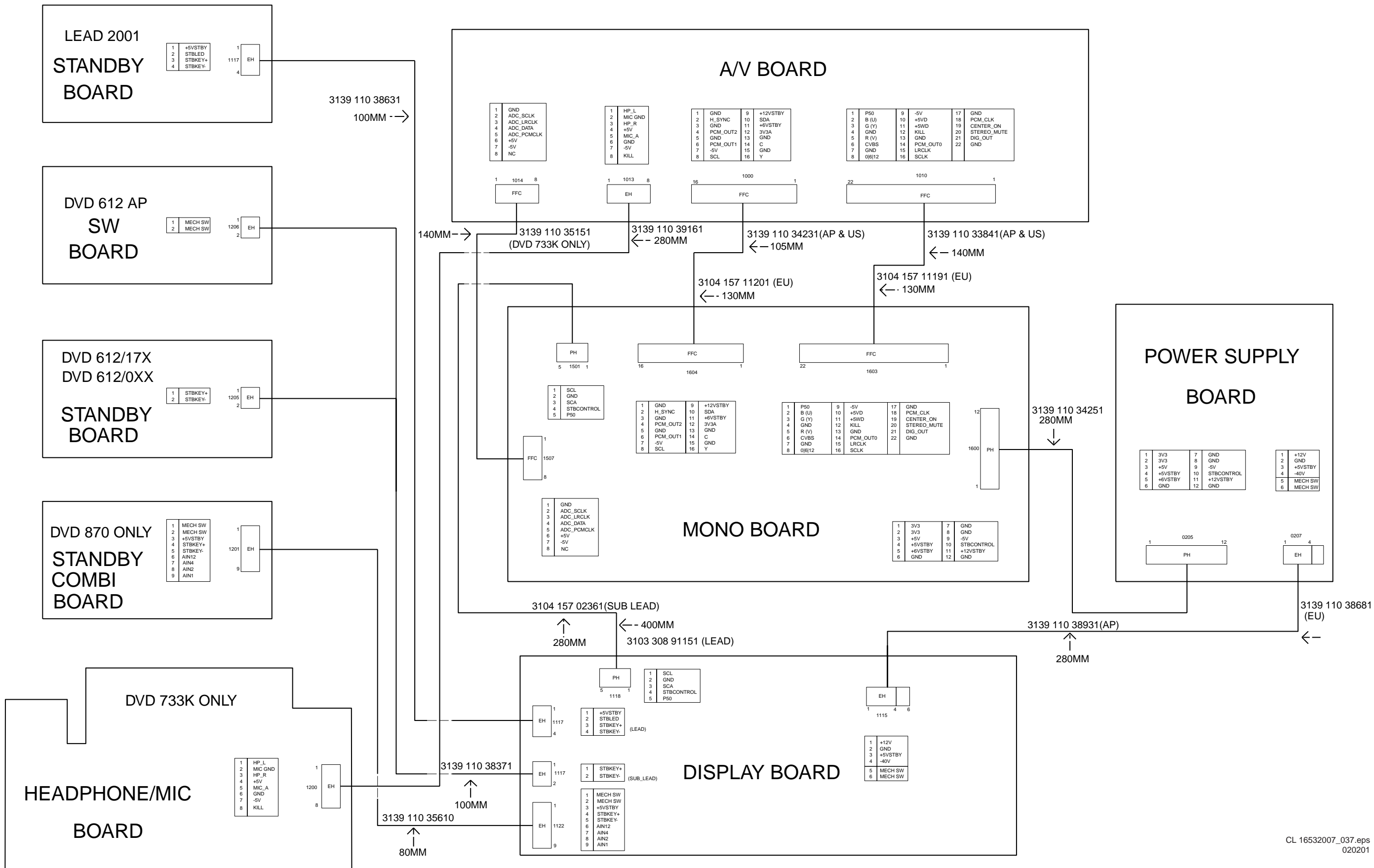

# 7. Electrical diagrams and Print-layouts

## Power Supply Unit VFM WR (3122 427 22600)

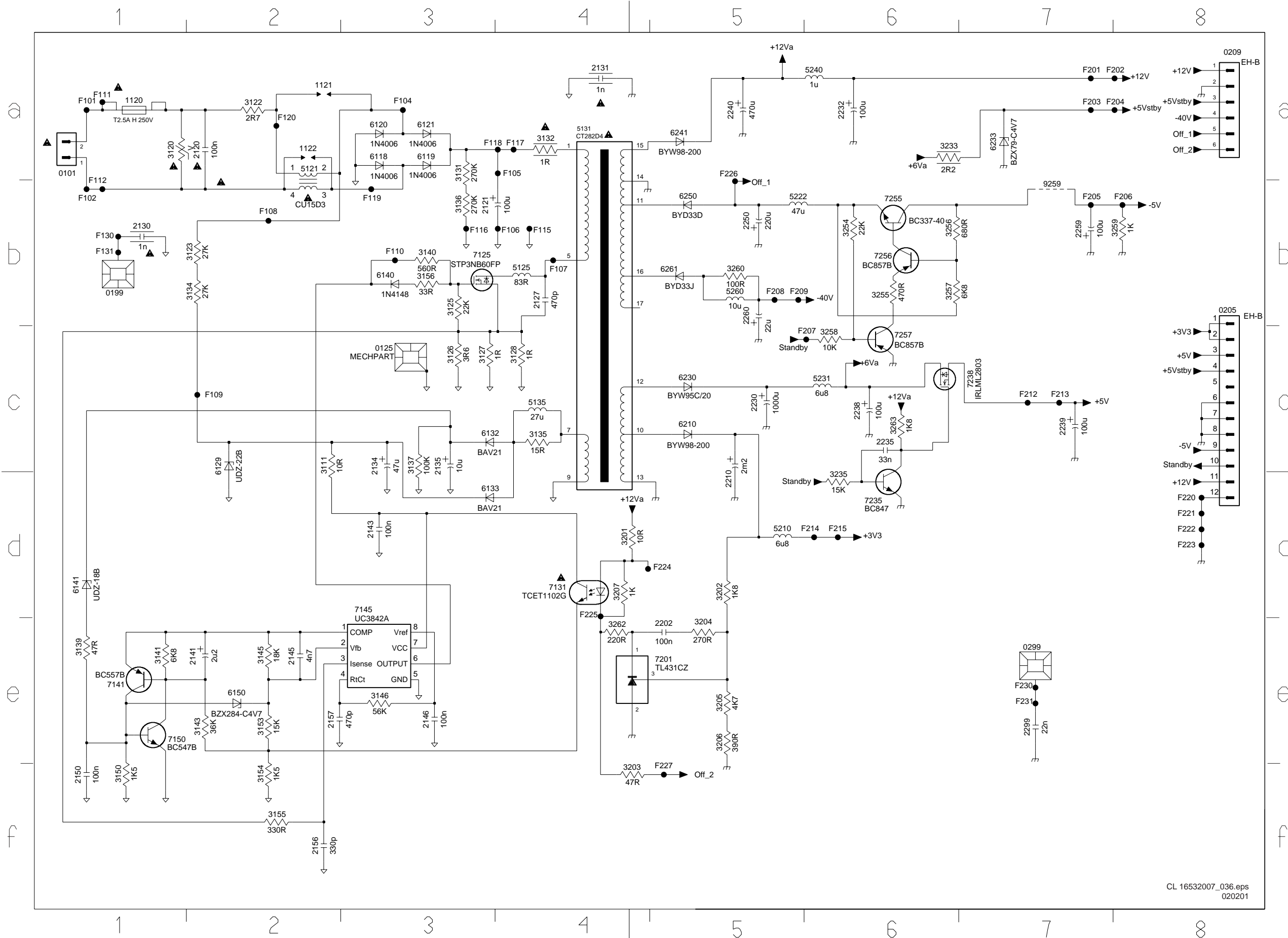

Layout Power Supply Unit VFM WR (component side)

0101	B10209	A9121	B3130	A4135	C5232	A8240	A7259	C8111	C4123	B23133	A3201	C6120	A2210	C5260	A6120	B3128	A4211	C6241	A7125	B4201	C6259	C8203	B8259	C7
0125	C40299	A8222	C22131	C52141	C3233	A8241	A6260	A7112	C5126	B43134	C3232	B6121	B2222	C6110	C3121	A3132	C5230	B6250	B67131	C6233	A8122	C2204	C9	
0199	A4120	C1223	B3132	C5210	C7236	B6250	C6261	A7120	C13127	B43135	C5233	C8125	B45230	B7111	C3122	C3133	C5231	B6259	C7141	C3236	B7125	B4205	B9	
0205	C9119	B22127	B4133	C5211	B7238	B7251	B6263	A63121	C3128	B43140	B4262	C6131	B6231	B7118	A3123	B3140	C4233	C9260	A67145	C4237	B8201	C9206	B9	
0208	A9120	C22129	C4134	C5230	B7239	B8253	C7105	C13122	B23132	B43155	C4263	B6135	B5240	A7119	A6127	A4210	B7240	B6261	A67150	C3255	C7202	C7207	B9	

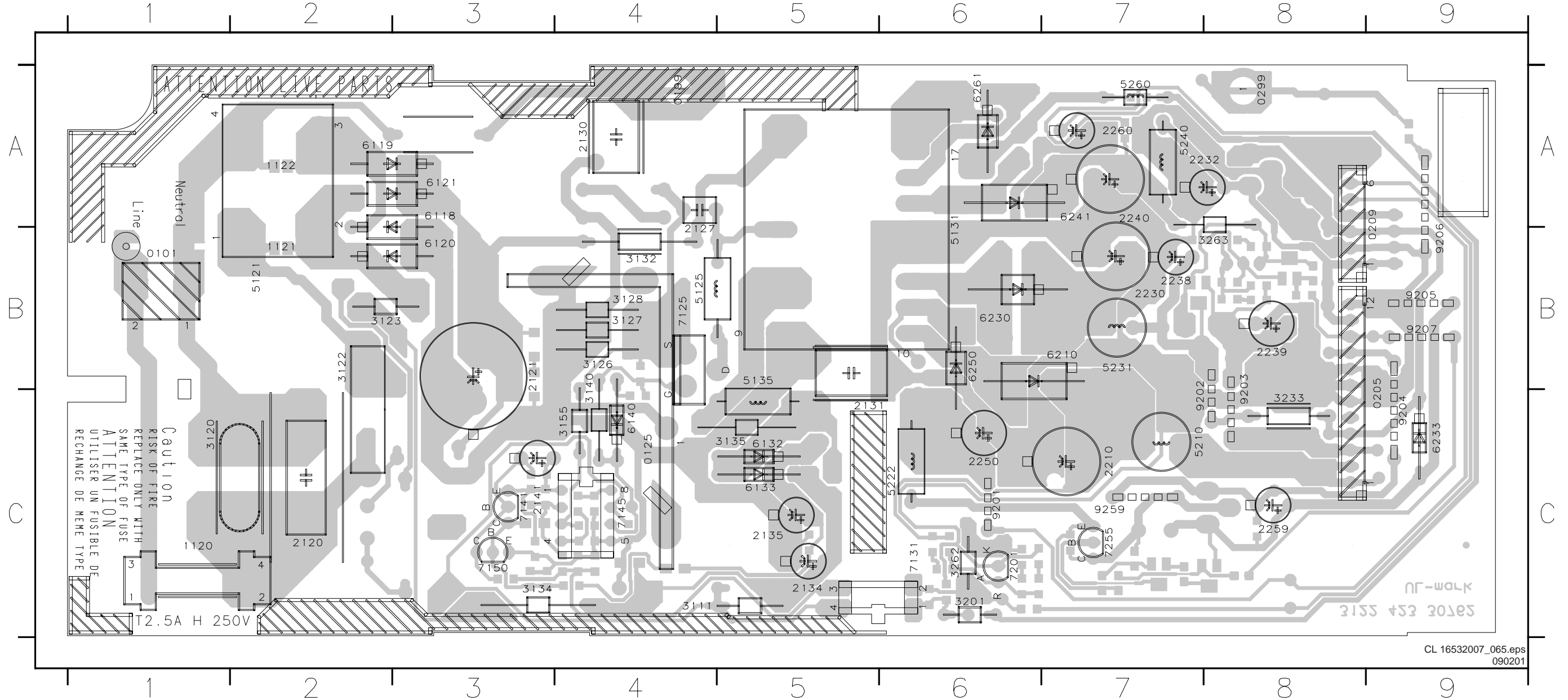

### Layout Power Supply Unit VFM WR (bottom side)

2142	A32146	A42156	A42202	A62235	B83125	B43137	A53143	A33150	A33156	A43204	A63207	A63235	B83241	B83255	A73258	A84201	B76141	A47238	B7
2143	A42150	A32157	A42203	A62262	B83131	B33139	A43145	A33153	A43202	A63205	A63208	A63236	B83253	A73256	A73259	A84202	C76150	A37256	A7
2145	A32152	A42201	A62234	B82299	C93136	B33141	A33146	A43154	A43203	A63206	A63234	B83237	B83254	A73257	A73260	C76129	A47235	B87257	A8

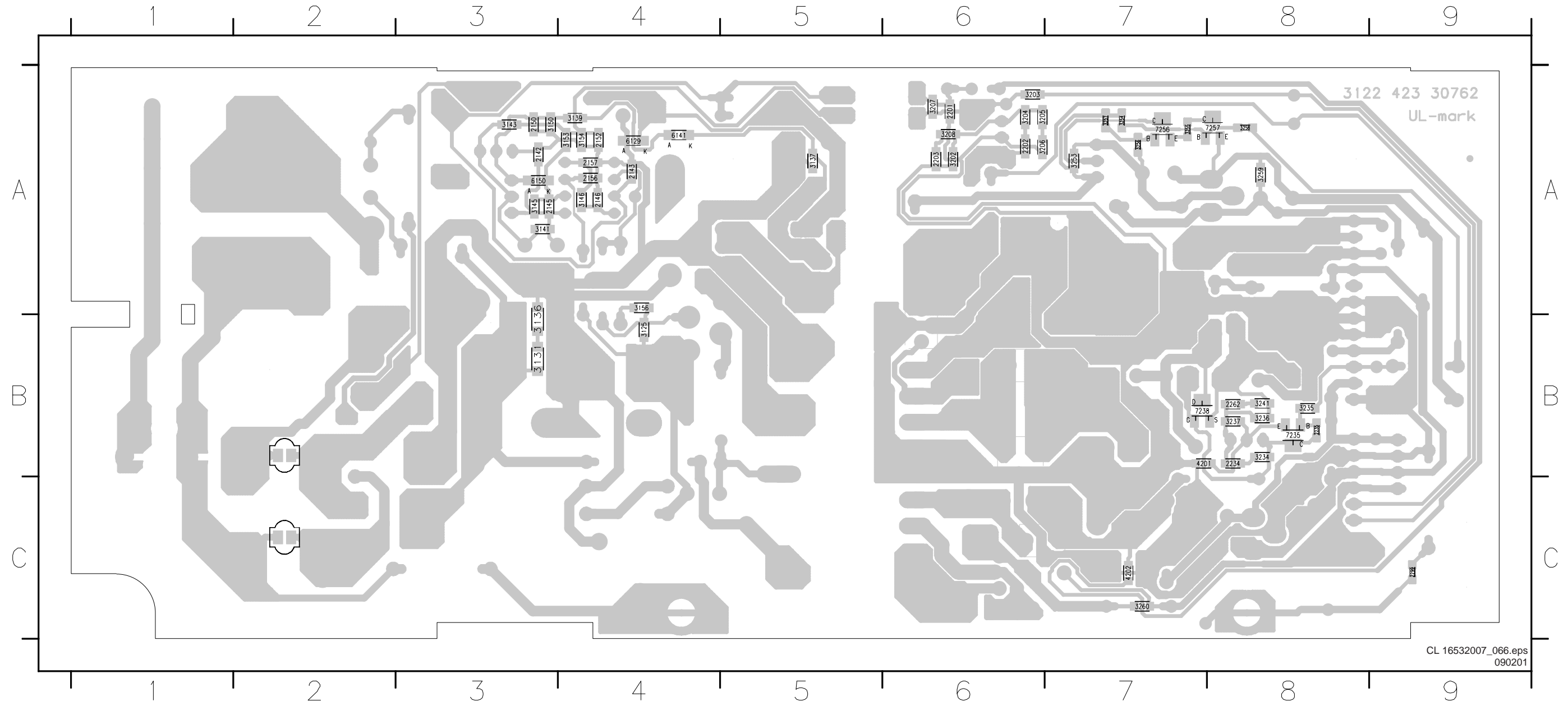

AV Board (Video control)

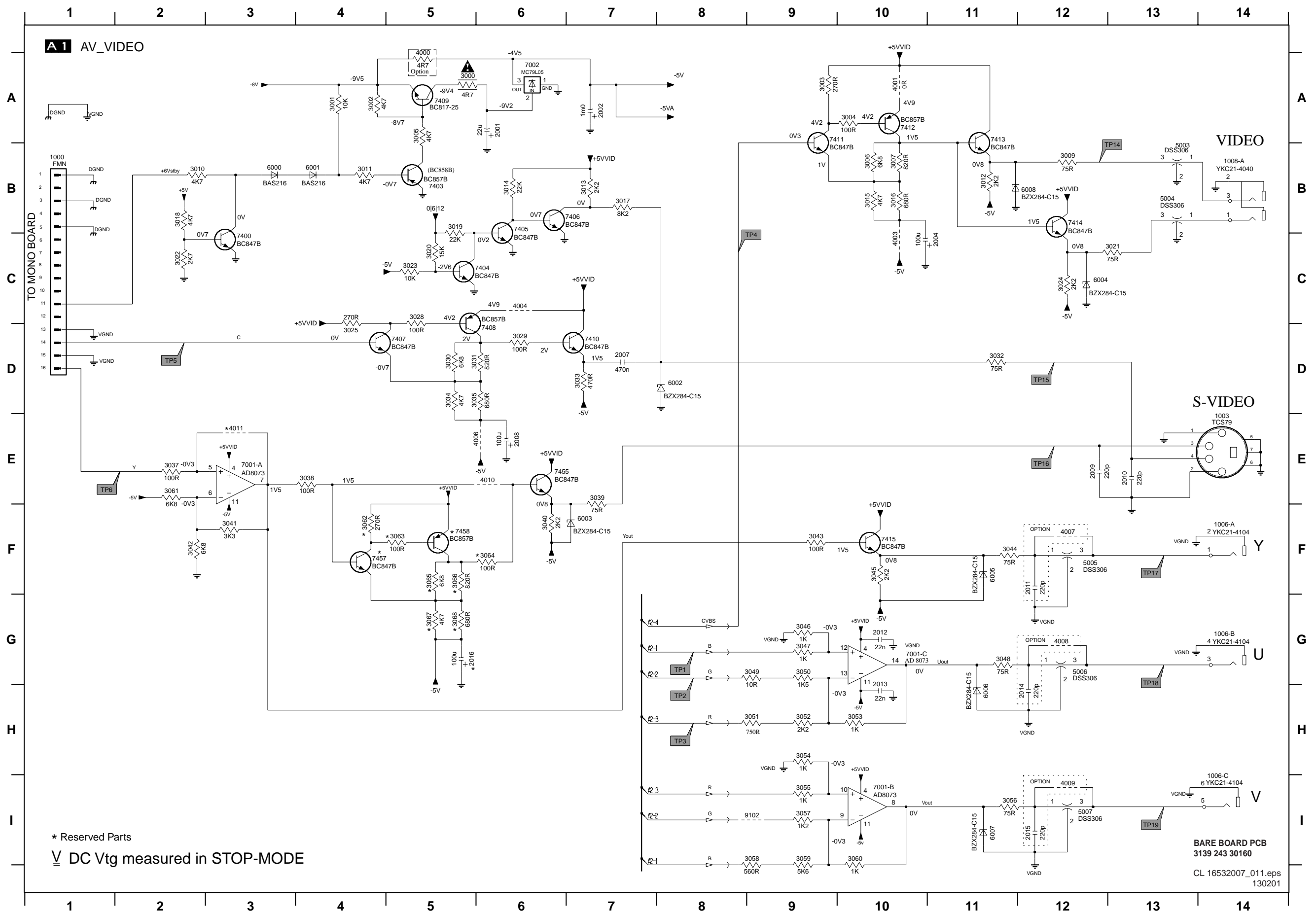

- 1000 B1
- 1003 E14
- 1006-A F14
- 1006-B G14
- 1006-C I14
- 1008-A B14
- 2001 A6
- 2002 A7
- 2004 C11
- 2007 D7
- 2008 E6
- 2009 E12
- 2010 E13
- 2011 F12
- 2012 G10
- 2013 H10
- 2014 H12
- 2015 I12
- 2016 G5
- 3000 A5
- 3001 A4
- 3002 A4
- 3003 A9
- 3004 A10
- 3005 A5
- 3006 B10
- 3007 B10
- 3009 B12
- 3010 B2
- 3011 B4
- 3012 B11
- 3013 B7
- 3014 B6
- 3015 B10
- 3016 B10
- 3017 B7
- 3018 B2
- 3019 B5
- 3020 C5
- 3021 C13
- 3022 C2
- 3023 C5
- 3024 C12
- 3025 D4
- 3026 C5
- 3029 D6
- 3030 D5
- 3031 D6
- 3032 D11
- 3033 D7
- 3034 D5
- 3035 D6
- 3037 E2
- 3038 E4
- 3039 E7
- 3040 F6
- 3041 F3
- 3042 F2
- 3043 F9
- 3044 F11
- 3045 F10
- 3046 G9
- 3047 G9
- 3048 G11
- 3049 G9
- 3050 G9
- 3051 H9
- 3052 H9
- 3053 H10
- 3054 H9
- 3055 I9
- 3056 I11
- 3057 I9
- 3058 I9
- 3059 I10
- 3060 I10
- 3061 E2
- 3062 F4
- 3063 F5
- 3064 F6
- 3065 F5
- 3066 F5
- 3067 G5
- 3068 G5
- 4000 A5
- 4001 A10
- 4003 C10
- 4004 C6
- 4006 E6
- 4007 F12
- 4008 G12
- 4009 I12
- 4010 E6
- 4011 E3
- 5003 B13
- 5004 B13
- 5005 F12
- 5006 G12
- 5007 H2
- 6000 B3
- 6001 B4
- 6002 D8
- 6003 F7
- 6004 C12
- 6005 F11
- 6006 H11
- 6007 I11
- 6008 B12
- 7001-A E3
- 7001-B I10
- 7001-C G10
- 7002 A6
- 7400 C3
- 7403 B5

\* Reserved Parts  
 V DC Vtg measured in STOP-MODE

BARE BOARD PCB  
 3139 243 30160  
 CL 16532007\_011.eps  
 130201

### AV Board (Sound)

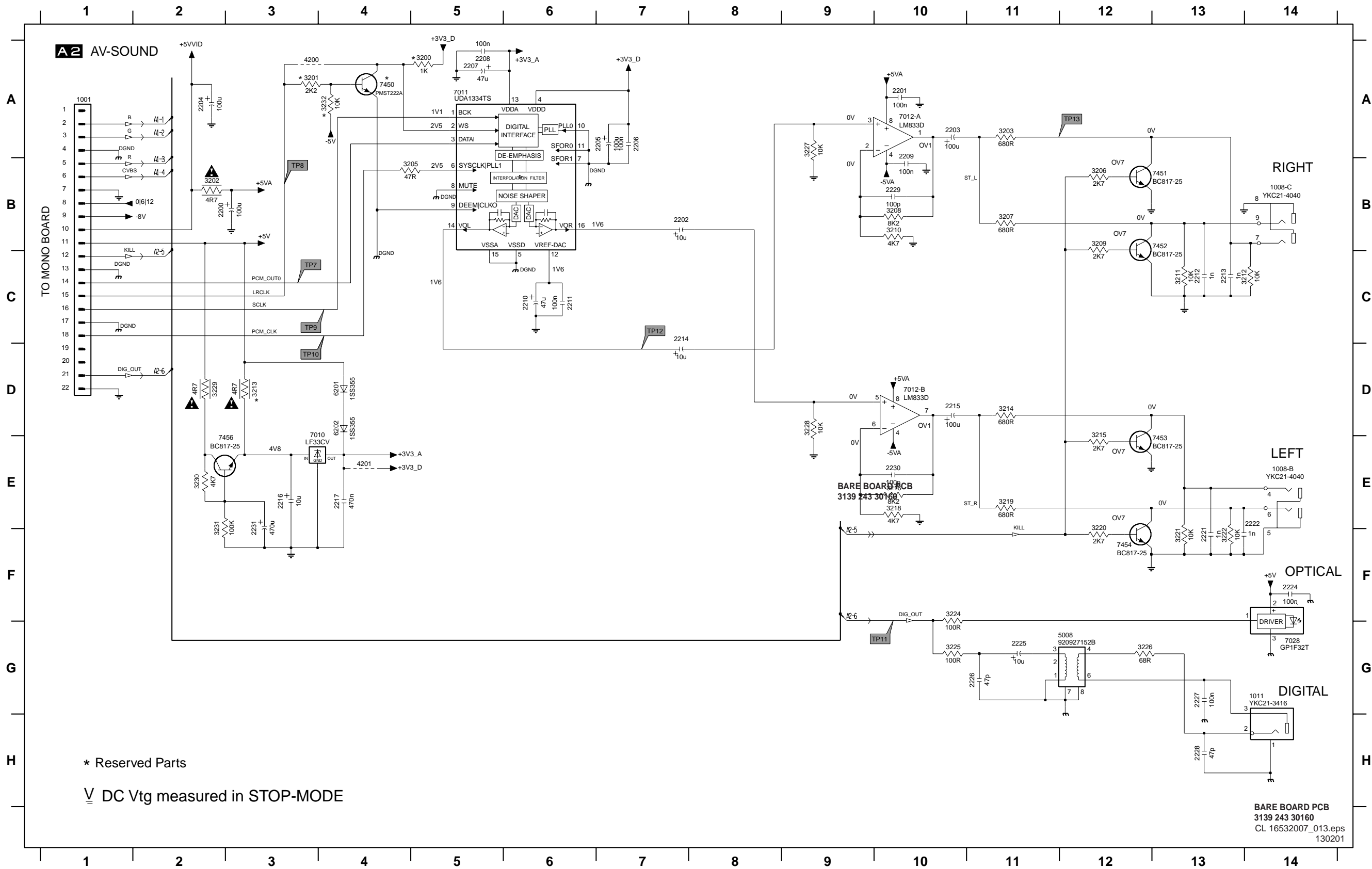

\* Reserved Parts

V DC Vtg measured in STOP-MODE

- 1001 A1
- 1008-B E14
- 1008-C B14
- 1011 G14
- 2200 B2
- 2201 A10
- 2202 B7
- 2203 A10
- 2204 A2
- 2205 A7
- 2206 A7
- 2207 A5
- 2208 A5
- 2209 B10
- 2210 C6
- 2211 C6
- 2212 C13
- 2213 C13
- 2214 C7
- 2215 D10
- 2216 E3
- 2217 E4
- 2221 F13
- 2222 E14
- 2224 F14
- 2225 G11
- 2226 G11
- 2227 G13
- 2228 H13
- 2229 B10
- 2230 E10
- 2231 E3
- 3200 A5
- 3201 A3
- 3202 B2
- 3203 A11
- 3205 B4
- 3206 B12
- 3207 B11
- 3208 B10
- 3209 B12
- 3210 B10
- 3211 C13
- 3212 C14
- 3213 D3
- 3214 D11
- 3215 E12
- 3216 E10
- 3218 E10
- 3219 E11
- 3220 F12
- 3221 F13
- 3222 F13
- 3224 F10
- 3225 G10
- 3226 G12
- 3227 A9
- 3228 D9
- 3229 D2
- 3230 E2
- 3231 E2
- 3232 A4
- 4200 A3
- 4201 E4
- 5008 G11
- 6201 D4
- 6202 D4
- 7010 E3
- 7011 A5
- 7012-A A10
- 7012-B D10
- 7028 G14
- 7450 A4
- 7451 B13
- 7452 B13
- 7453 E13
- 7454 F12
- 7456 D3

Layout A/V Board (component side)

1000 A6	1008 C6	2004 B7	2202 A5	2207 A5	2216 B2	3037 B8	3205 B5	5004 C8	5008 C4	9000 A4	9004 A4	9010 B8	9014 A10	TF00 C6
1001 B4	1011 C5	2008 B10	2203 C6	2210 A4	2225 C4	3038 A11	3224 C5	5005 C10	7002 A1	9001 A4	9005 B5	9011 B9	9016 A8	TF01 C7
1003 C11	2001 A2	2016 A11	2204 B8	2214 B6	2231 B1	3040 B11	3225 C5	5006 C9	7010 B2	9002 B3	9006 B9	9012 A9	9017 A10	TF02 C6
1006 C9	2002 A3	2200 A7	2205 B4	2215 B7	3033 B11	3049 B9	5003 C7	5007 C8	7028 C4	9003 B4	9008 A7	9013 A9	9102 A9	

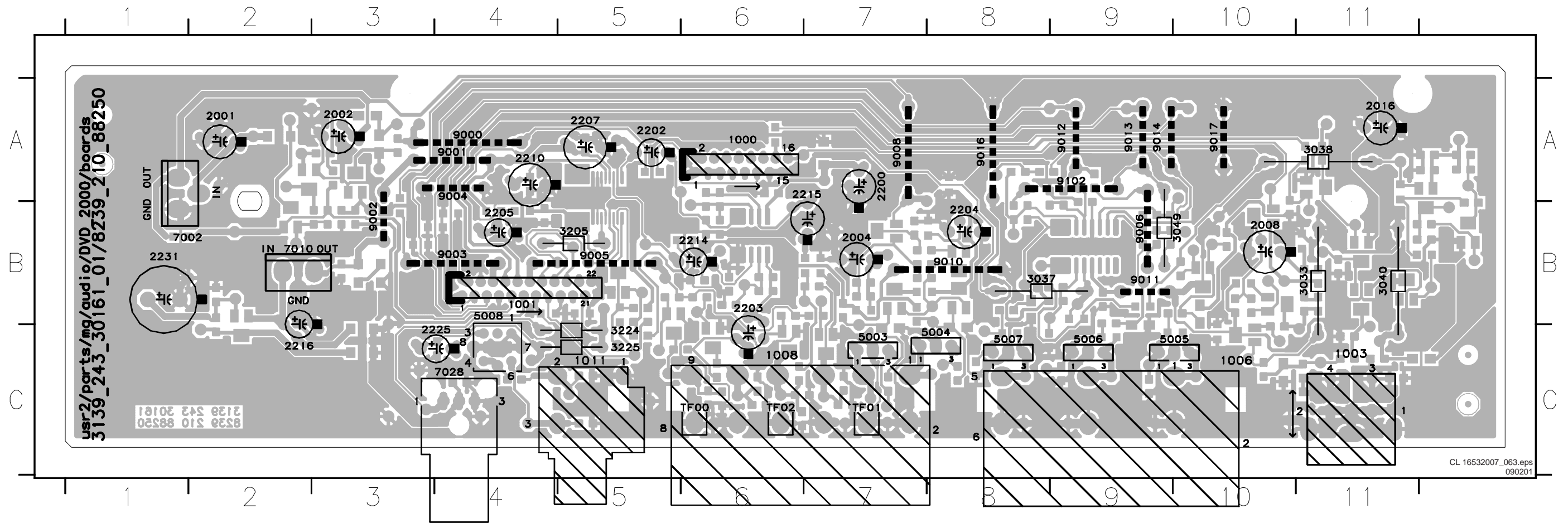

AV Board (bottom side)

20007	C2	22111	A8	30000	A10	30113	C1	30025	B2	30444	B2	30557	B4	32000	B7	32114	B5	32330	C10	40111	B3	43008	A6	60004	C4	74004	A1	74550	B7
20009	C1	22112	C6	30001	A9	30014	B1	30028	B2	30445	B2	30558	A4	32001	A5	32115	B5	32331	B7	40117	B3	43009	A7	60005	B2	74005	B1	74551	C6
20110	C3	22113	C6	30002	A9	30015	B5	30029	C2	30446	B2	30559	A4	32002	A5	32116	B5	32332	B7	40118	B3	43010	B5	60006	C2	74006	B1	74552	B6
20111	C3	22117	B9	30003	A9	30016	B5	30030	B1	30447	B2	30560	B4	32003	B6	32117	B5	32333	B7	40200	B3	43011	B5	60007	C4	74007	A2	74553	C6
20112	C3	22221	C5	30004	A9	30017	B5	30031	B1	30448	B2	30561	B4	32004	B6	32118	B5	32334	B7	40201	B3	43012	B5	60008	B4	74008	A2	74554	B5
20113	C3	22222	C8	30005	A9	30018	B9	30032	C1	30449	B2	30562	B4	32005	B6	32119	B5	32335	B7	40202	B3	43013	B5	60009	C2	74009	A2	74555	C6
20114	C3	22224	C8	30006	A9	30019	B9	30033	C1	30450	B2	30563	B4	32006	B6	32120	B5	32336	B7	40203	B3	43014	B5	60010	C2	74010	A2	74556	C6
20115	C4	22226	C8	30007	A9	30020	A1	30034	B1	30451	B3	30564	B1	32007	B7	32121	B5	32337	B7	40204	B3	43015	C2	60011	B3	74011	A7	74557	B5
22001	A6	22227	C7	30009	C5	30021	C4	30035	C1	30452	A3	30565	A1	32008	C2	32122	B5	32338	B7	40205	B3	43016	A9	60012	A7	74012	B6	74558	B1
22006	B8	22228	C7	30010	A9	30022	B2	30036	B3	30453	A3	30566	A1	32009	C6	32123	B5	32339	B7	40206	B3	43017	A9	60013	A7	74013	B6	74559	C6
22008	A7	22229	B6	30011	A9	30023	B2	30037	C4	30454	A3	30567	A1	32010	C6	32124	B5	32340	B7	40207	B3	43018	C2	60014	A9	74014	A4	74560	B1
22009	B6	22230	A6	30012	B5	30024	B5	30038	B2	30455	B4	30568	A1	32011	C9	32125	B5	32341	B7	40208	B3	43019	C1	60015	A10	74015	B2	74561	B1

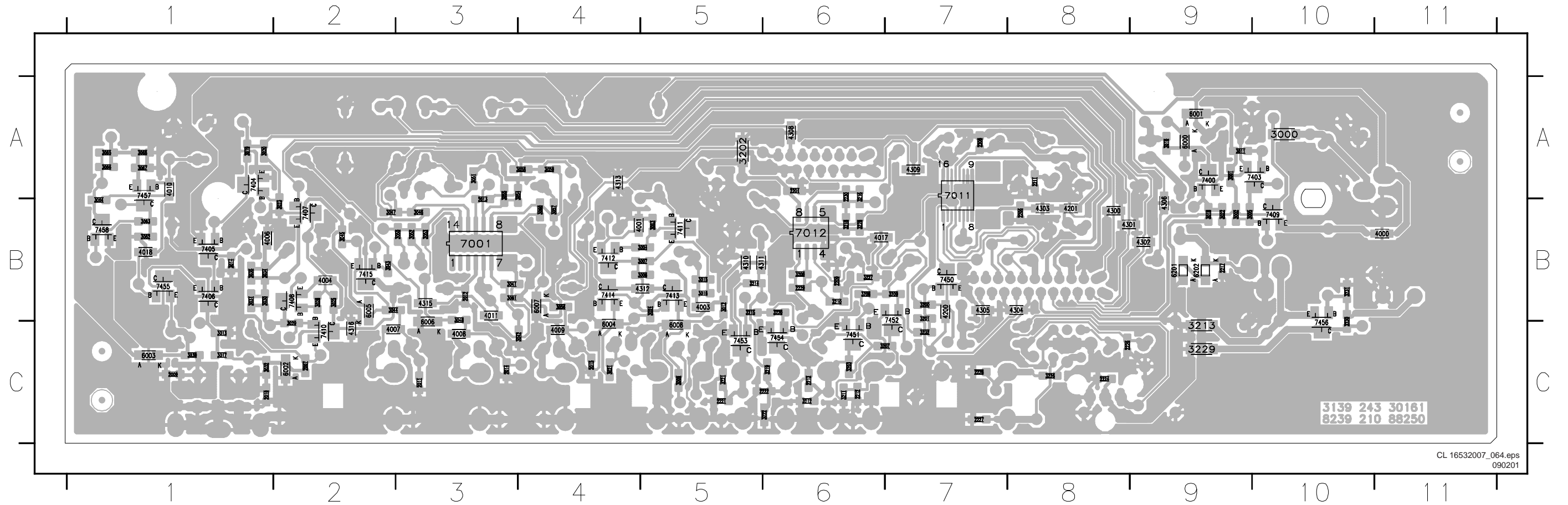



Display board

DISPLAY PANEL

V DC vtg measured in STOP-MODE

Diversity table for all items no marked with #

ITEM	Model using Mech SW	Model using Tact SW
1115	6P conn	4P conn
3155	--	Jumper
3156	--	Jumper
3157	Jumper	--
3158	Jumper	--

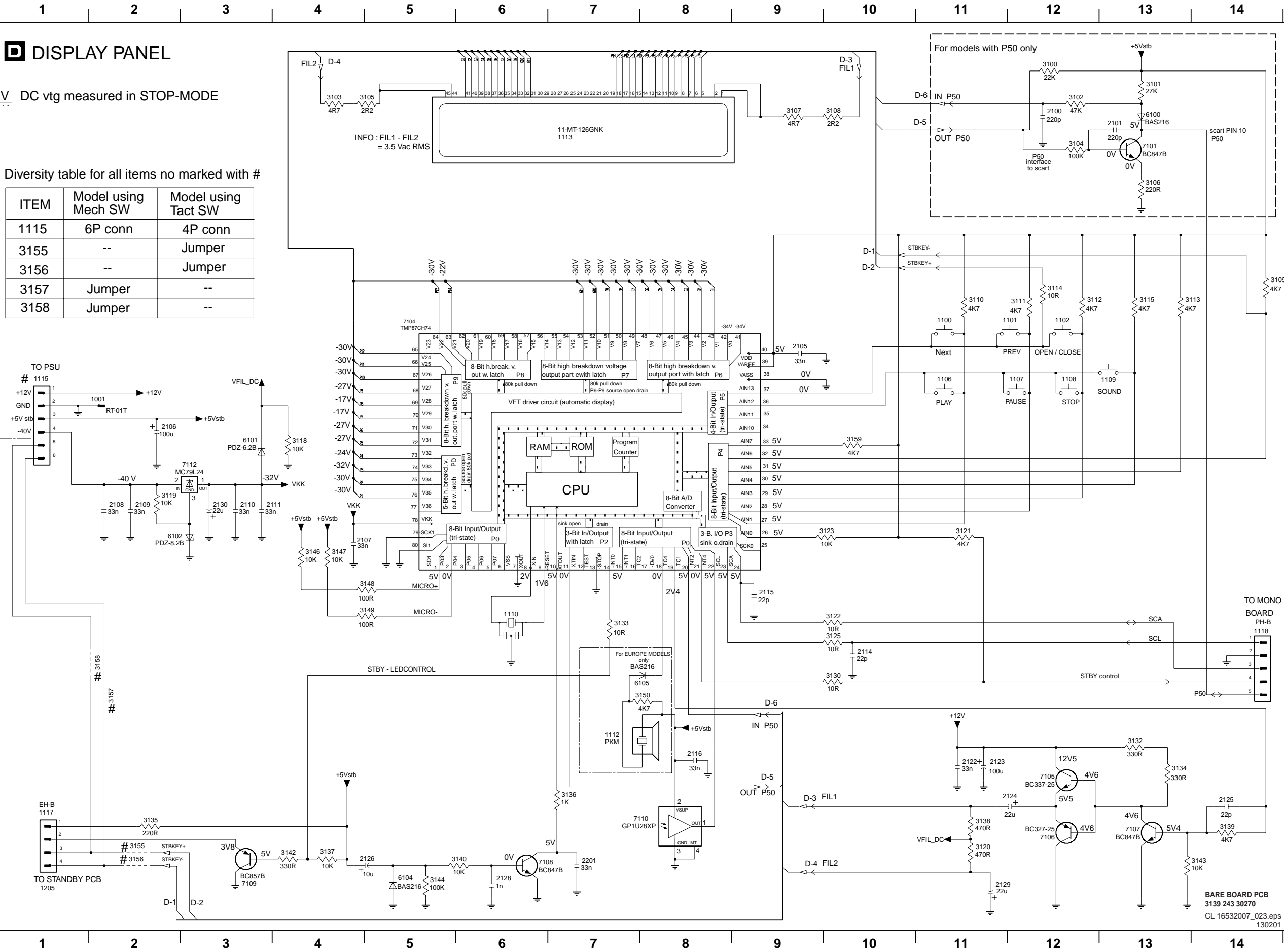

- 1001 D2
- 1100 C11
- 1101 C12
- 1102 C12
- 1106 D11
- 1107 D12
- 1108 D12
- 1109 D13
- 1110 G6
- 1112 H7
- 1113 A7
- 1115 D1
- 1117 I1
- 1118 G14
- 2100 A12
- 2101 A13
- 2105 D9
- 2106 D2
- 2107 F4
- 2108 E2
- 2109 E2
- 2110 E3
- 2111 E4
- 2114 G10
- 2115 F9
- 2116 H8
- 2122 H11
- 2123 H11
- 2124 I12
- 2125 I14
- 2126 I5
- 2128 I6
- 2129 I11
- 2130 E3
- 2201 I7
- 3100 A12
- 3101 A13
- 3102 A12
- 3103 A4
- 3104 A12
- 3105 A5
- 3106 B13
- 3107 A9
- 3108 A10
- 3109 C14
- 3110 C11
- 3111 C12
- 3112 C12
- 3113 C14
- 3114 C12
- 3115 C13
- 3118 E4
- 3119 E2
- 3120 I11
- 3121 F11
- 3122 G10
- 3123 F10
- 3125 G10
- 3130 G10
- 3132 H13
- 3133 G7
- 3134 H13
- 3135 I2
- 3136 H7
- 3137 I4
- 3138 I11
- 3139 I14
- 3140 I6
- 3142 I4
- 3143 I4
- 3144 I5
- 3146 F4
- 3147 F4
- 3148 F5
- 3149 F5
- 3150 G8
- 3155 I2
- 3156 I2
- 3157 G2
- 3158 G2
- 3159 E10
- 6100 A13
- 6101 E3
- 6102 F2
- 6104 I5
- 6105 G8
- 7101 A13
- 7104 C5
- 7105 H12
- 7106 H12
- 7107 H3
- 7108 I6
- 7109 I3
- 7110 I8
- 7112 E3
- F102 D5
- F103 D5
- F108 A5
- F109 A9
- F119 C7
- F120 C7
- F121 C7
- F122 C8
- F123 C8
- F124 C8
- F125 C5
- F129 C7
- F130 C7
- F131 C7
- F132 C8
- F133 C8
- F137 D5
- F138 D5
- F139 D5
- F140 H8
- F141 D5
- F142 D9
- F143 A12
- F144 A12
- F145 G8
- F146 D3
- F147 E3
- F148 D1
- F150 E5
- F151 E5
- F152 E9
- F153 C5
- F154 E5
- F155 E9
- F156 E5
- F157 E9
- F158 E5
- F159 E9
- F160 E9
- F161 E9
- F162 I6
- F163 I7
- F164 H6
- F165 A13
- F166 A13
- F167 B13
- F168 F1
- F169 F1
- F183 I1
- F184 I1
- F186 E9
- F203 D2
- F205 E1
- F208 G13
- F209 G13
- F210 G13
- F228 D1
- F233 D9
- F234 I1
- F235 I1
- F241 G14
- F242 G14

**Layout Display Board (component side)**

1001 A1 1101 A9 1106 A9 1108 A9 1110 A7 1113 A4 1117 A1 2106 A9 2124 A9 2129 A2 7105 A9 7110 A2 9201 A1  
 1100 A9 1102 A8 1107 A8 1109 A8 1112 A9 1115 A8 1118 A1 2123 A9 2126 A1 2130 A6 7106 A9 7112 A6 9202 A8

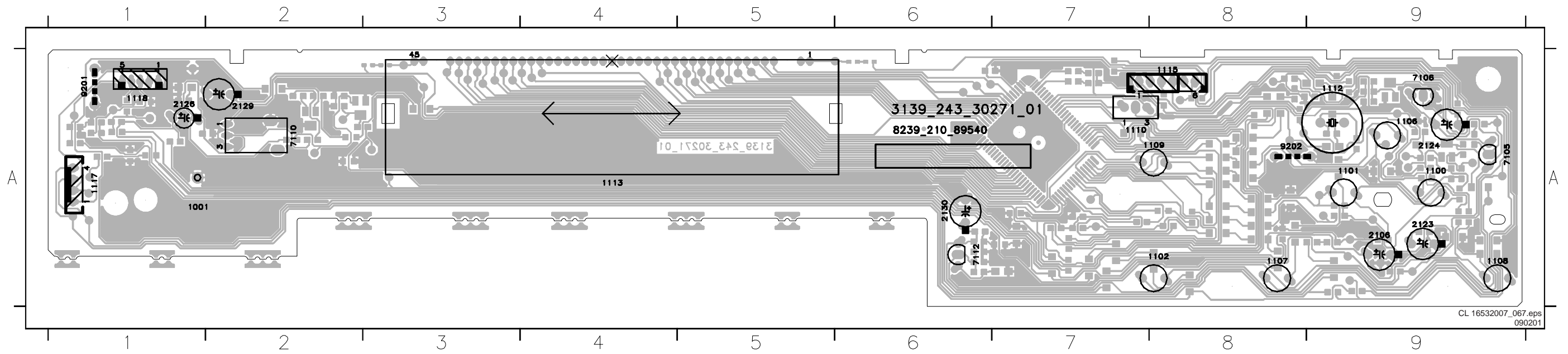

**Layout Display Board (bottom side)**

2100 A1 2110 A4 2125 A1 3103 A7 3109 A3 3115 A1 3123 A3 3135 A9 3142 A8 3149 A3 3159 A3 4006 A3 4013 A2 4019 A2 4025 A2 4031 A2 4037 A2 4103 A1 4109 A1 4115 A8 4122 A3 6101 A1 7107 A1  
 2101 A1 2111 A4 2126 A1 3104 A1 3110 A1 3118 A1 3124 A3 3132 A3 3140 A1 4001 A2 4007 A3 4014 A2 4020 A2 4026 A2 4032 A2 4038 A1 4104 A2 4110 A2 4117 A3 4125 A2 6102 A3 7108 A8  
 2105 A3 2114 A9 2201 A8 3105 A7 3111 A1 3119 A4 3127 A3 3134 A9 4002 A3 4008 A3 4015 A1 4021 A2 4027 A2 4033 A2 4039 A1 4105 A1 4111 A2 4118 A3 4124 A2 6104 A9 7109 A8  
 2107 A4 2115 A9 3100 A1 3106 A1 3112 A1 3120 A2 3128 A2 3136 A9 4003 A1 4010 A3 4016 A2 4022 A2 4028 A2 4034 A7 4106 A1 4112 A1 4119 A3 4125 A2 6105 A1  
 2108 A4 2116 A8 3101 A1 3107 A4 3113 A9 3121 A9 3129 A1 3137 A1 4004 A1 4011 A1 4017 A2 4023 A1 4029 A3 4035 A2 4107 A1 4113 A1 4120 A8 4126 A9 7101 A1  
 2109 A4 2122 A1 3102 A1 3108 A4 3114 A1 3122 A9 3130 A1 4005 A1 4012 A8 4018 A2 4024 A2 4030 A2 4036 A2 4108 A3 4114 A3 4121 A9 6100 A1 7104 A3

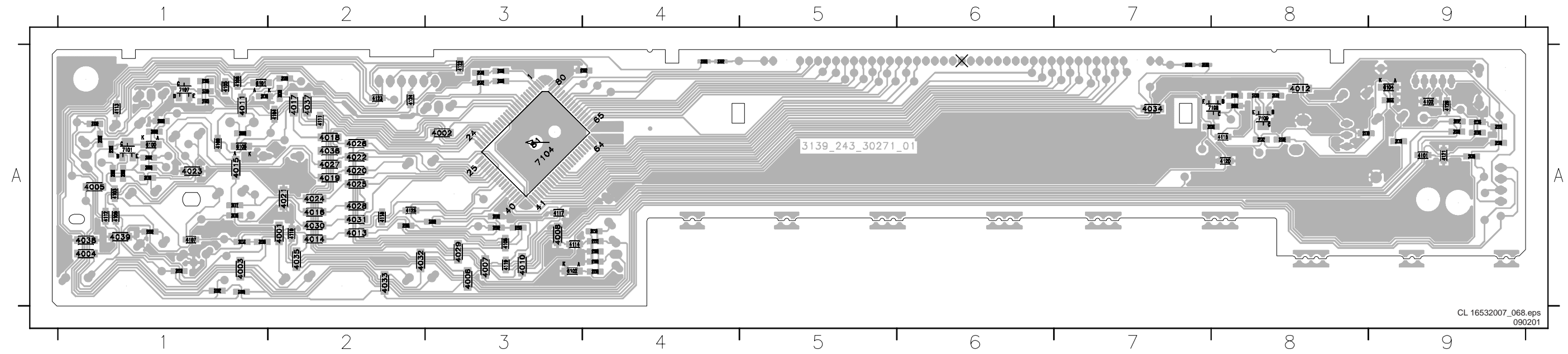

Bare board Standby

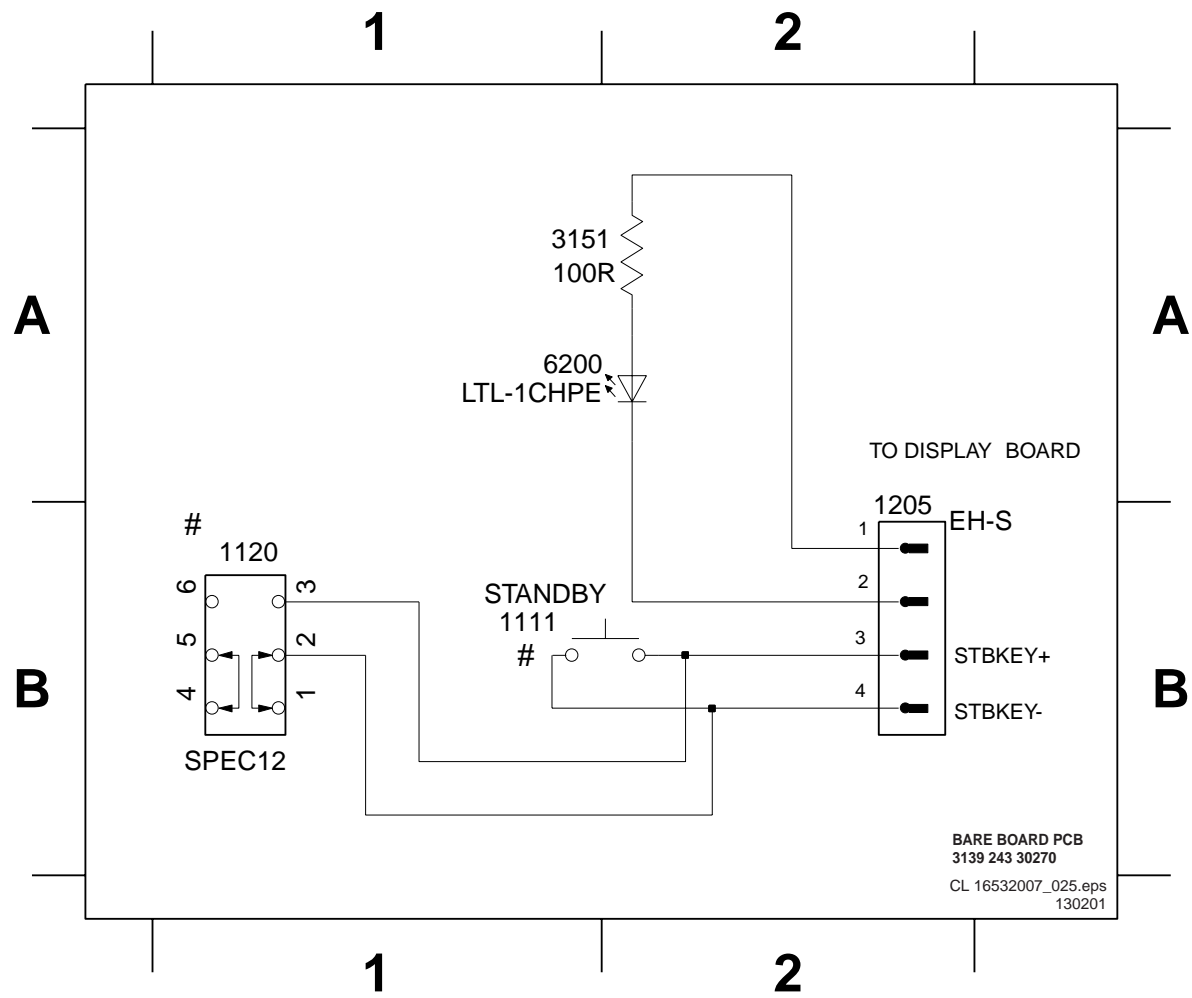

- 1111 B1
- 1120 B1
- 1205 B2
- 3151 A1
- 6200 A1
- F236 A2
- F237 A1
- F238 B1
- F239 B2
- F240 B2

BARE BOARD PCB  
3139 243 30270  
CL 16532007\_025.eps  
130201

Layout Bare board Standby (component side)

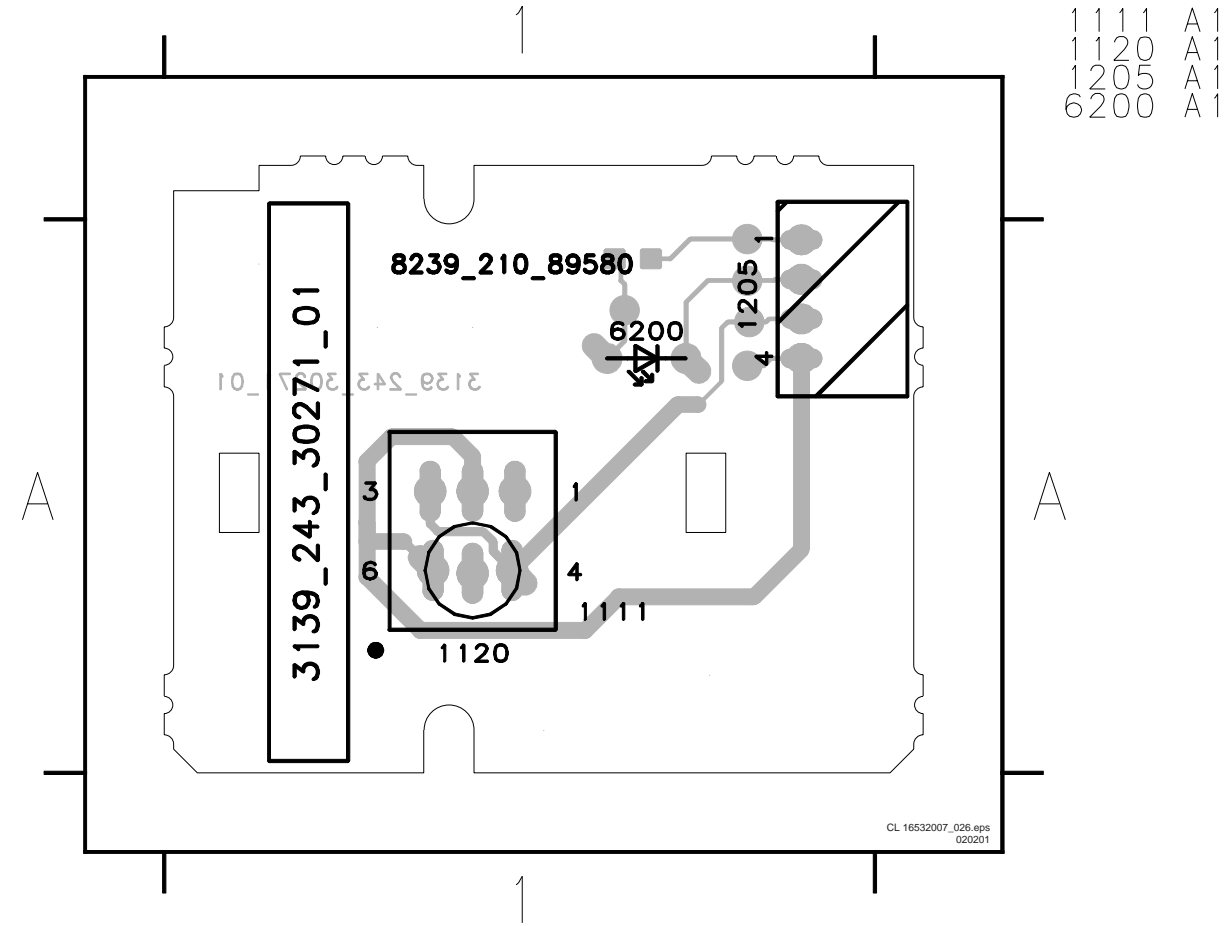

- 1111 A1
- 1120 A1
- 1205 A1
- 6200 A1

Layout Bare board Standby (component side)

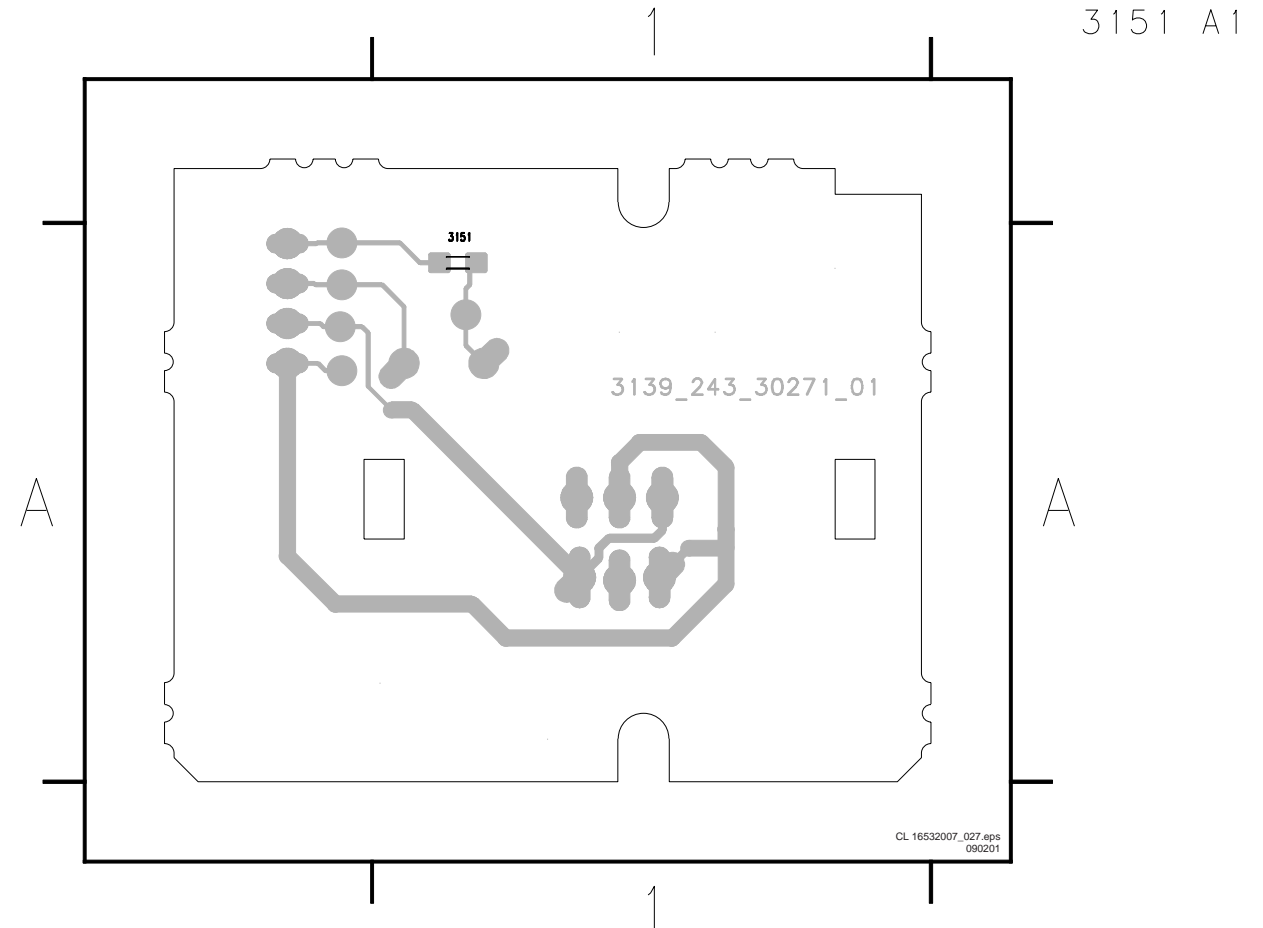

DIVERSITY

#	MODEL USING MECH SWITCH SW	MODEL USING TACT SWITCH SW
1120	YES	
1111		YES